



# HP Latex 700 Printer Series HP Latex 800 Printer Series Site Preparation Guide

## SUMMARY

You are responsible for preparing the physical site for the installation of the printer.



---

# Table of contents

<b>1 Overview</b> .....	<b>1</b>
Documentation.....	1
Customer responsibility .....	1
Installation time schedule.....	1
<b>2 Site preparation requirements</b> .....	<b>3</b>
Physical space requirements.....	3
Designing the optimal print production area.....	6
RIP workstation characteristics.....	7
Networking.....	7
Printing supplies.....	8
Return the site preparation checklist.....	8
Electrical configuration.....	8
Powerline disturbances.....	13
Grounding.....	13
<b>3 Site preparation checklist</b> .....	<b>15</b>



---

# 1 Overview

Your printer is supplied ready to use after a few simple installation procedures described in detail in the assembly instructions. It is important to read the information provided in the site preparation guide thoroughly and to ensure complete compliance with all installation and operation requirements.

Safety procedures, warnings, cautions, and local regulations must all be adhered to. A well-prepared site helps to provide a smooth and easy installation.

## Documentation

A full set of manuals are provided with your printer, and can also be downloaded.

Manuals can be downloaded from: <http://www.hp.com/go/latex700-800series/manuals>.

- Introductory information
- Limited warranty
- Legal information
- Site preparation guide (this guide)
- Assembly instructions
- User guide

## Customer responsibility

You are responsible for preparing the physical site for the installation of the printer.

- Prepare the building's electrical system to meet the printer's requirements and the Electrical Code requirements according to the local jurisdiction of the country where the equipment is installed. See [Electrical configuration on page 8](#).

---

 **NOTE:** Make sure that a certified electrician reviews the setup and configuration of the electrical system used to power the printer. See [Electrical configuration on page 8](#).

---

- Meet temperature and humidity requirements and ensure proper ventilation for the printer. See [Environmental specifications on page 4](#).
- Meet all requirements for RIP, networking and printing supplies. See [RIP workstation characteristics on page 7](#), [Networking on page 7](#), and [Printing supplies on page 8](#).
- Prepare the unloading route so that the printer can be unloaded and maneuvered into place. See [Unloading route on page 3](#).

## Installation time schedule

Allow a minimum of 3.5 hours for the installation of 700 series printers, and 3 hours for 800 series printers. The installer may require the help of another person to perform certain tasks during installation.



## 2 Site preparation requirements

Before installing the printer, you must check that your site is compatible with the printer and ready to receive it.

Most of the installation process can be handled by one person, but two people may be needed to perform certain tasks.

 **IMPORTANT:** For the 700 printer series, 5 people are needed to rotate the printer.

### Physical space requirements

Site preparation must accommodate for a specific unloading route, environmental specifications, ventilation and air conditioning requirements.

#### Unloading route

There are factors to consider when planning the movement of the printer from the unloading area to the installation site.

The route between the unloading area of the printer and the installation site, including any corridors and doorways through which the printer must be transported, is important to proper site preparation and must be checked before the arrival of the printer. This pathway must be clear when the printer arrives.

**Table 2-1** Physical specifications with packaging

Printer model	Length	Width	Height	Weight
700	2800 mm (110.2 in)	1130 mm (44.5 in)	1271 mm (50.0 in)	362 kg (798 lb)
700 W	2800 mm (110.2 in)	1130 mm (44.5 in)	1271 mm (50.0 in)	368 kg (811 lb)
800	2753 mm (108.4 in)	1100 mm (43.3 in)	1734 mm (68.3 in)	430 kg (948 lb)
800 W	2753 mm (108.4 in)	1100 mm (43.3 in)	1734 mm (68.3 in)	437 kg (963 lb)

**Table 2-2** Physical specifications without packaging

Printer model	Length	Width	Height	Weight
700 (curing module down)	2583 mm (101.7 in)	852 mm (33.5 in)	1402 mm (55.2 in)	261 kg (575 lb)
700 (curing module up)	2583 mm (101.7 in)	776 mm (30.6 in)	1869 mm (73.6 in)	261 kg (575 lb)
700 W (curing module down)	2583 mm (101.7 in)	852 mm (33.5 in)	1402 mm (55.2 in)	267 kg (589 lb)
700 W (curing module up)	2583 mm (101.7 in)	776 mm (30.6 in)	1869 mm (73.6 in)	267 kg (589 lb)
800 (curing module down)	2583 mm (101.7 in)	866 mm (34.1 in)	1402 mm (55.2 in)	292 kg (644 lb)
800 (curing module up)	2583 mm (101.7 in)	776 mm (30.6 in)	1869 mm (73.6 in)	292 kg (644 lb)
800 (with beacon)	2583 mm (101.7 in)	866 mm (34.1 in)	1677 mm (66.0 in)	292 kg (644 lb)
800 W (curing module down)	2583 mm (101.7 in)	866 mm (34.1 in)	1402 mm (55.2 in)	300 kg (661 lb)

**Table 2-2** Physical specifications without packaging (continued)

Printer model	Length	Width	Height	Weight
800 W (curing module up)	2583 mm (101.7 in)	776 mm (30.6 in)	1869 mm (73.6 in)	300 kg (661 lb)
800 W (with beacon)	2583 mm (101.7 in)	866 mm (34.1 in)	1677 mm (66.0 in)	300 kg (661 lb)

Doorways without packaging: minimum width 1.01 m (40 in) × minimum height 1.67 m (66 in) required.

 **IMPORTANT:** Maximum ramp slope 12°.

The space required for assembly is 1.5 m (5 ft) front and rear, 7.7 m (25 ft 4 in) at the side, and 2.4 m (7 ft 11 in) in height.

The space required is illustrated in the following diagrams:

**Figure 2-1** 700 series

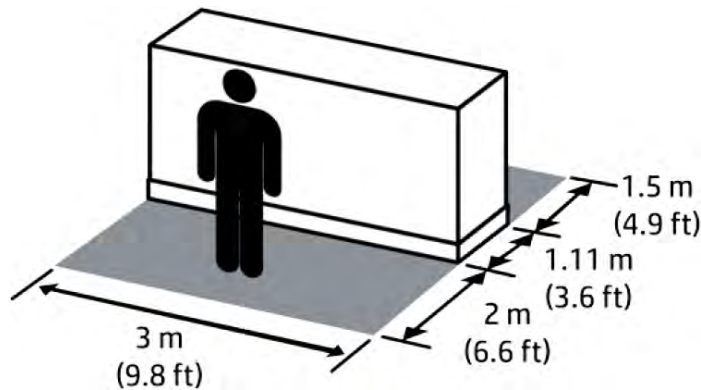

**Figure 2-2** 800 series

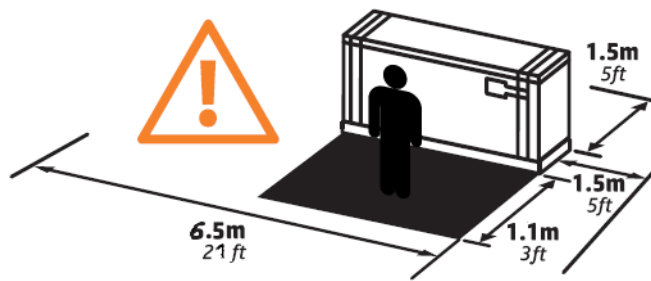

## Environmental specifications

These environmental conditions must be kept within the specified ranges to ensure the correct operation of the printer. Failure to do so may cause print-quality problems or damage sensitive electronic components.

**Table 2-3** Environmental specifications

Relative humidity range for best print quality	40–60%, depending on substrate type
Relative humidity range for printing	20–80%, depending on substrate type
Temperature range for best print quality	20 to 25°C (68 to 77°F), depending on substrate type
Temperature range for printing	15 to 30°C (59 to 86°F), depending on substrate type
Temperature range when not in operation	–15 to +55°C (+5 to +131°F)



**Table 2-3 Environmental specifications (continued)**

Temperature gradient	no more than 10°C/h (18°F/h)
Maximum altitude when printing	3000 m (10000 ft)

 **NOTE:** The printer must be kept indoors.

 **NOTE:** If the printer or Eco-Carton ink cartridges are moved from a cold location to a warm and humid location, water from the atmosphere can condense on the printer parts and cartridges and can result in ink leaks and printer errors. In this case, HP recommends that you wait at least 3 hours before turning on the printer or installing the Eco-Carton ink cartridges, to allow the condensation to evaporate.

In addition to controlling the temperature, humidity, and temperature gradient, there are other environmental conditions that must be met during site preparation:

- Do not install the printer where it will be exposed to direct sunlight or a strong light source.
- Do not install the printer in a dusty environment. Remove any accumulated dust before moving the printer into the area.

## Ventilation

Ensure that the room in which the system is installed meets local environmental, health, and safety (EHS) guidelines and regulations.

Adequate ventilation needs to be provided to ensure that potential airborne exposure is adequately controlled according to Safety Data Sheets. Consult the Safety Data Sheets available at <http://www.hp.com/go/msds> to identify chemical ingredients of your ink consumables.

Airborne materials can be readily identified and quantified by using established indoor air-quality testing protocols. HP performs these assessments during the development phase for all products.

HP testing shows that, during printer operation, the concentrations of airborne contaminants measured in the workspace are consistently well below key occupational exposure limits. This observation is based on exposure assessments that model very active productivity at customer facilities. Customers should recognize that actual levels in their facilities are dependent on workspace variables they control such as room size, ventilation performance, and duration of equipment use.

HP's assessment, based on the available scientific information, concluded that airborne materials are not expected to present a health hazard as long as you provide a minimum of 5 ACH (air changes per hour) of fresh air ventilation and a minimum room volume of 60 m<sup>3</sup>.

These specifications are valid for one HP printer using a black area-fill print at 4 passes and 100% ink density, assuming 8 h printing time per day. If there is other equipment in the room or different printing conditions, the ventilation rate should be recalculated accordingly.

As an alternative to the workspace benefit provided by general room ventilation, you could choose localized ventilation to provide a more comfortable working environment. See [Local exhaust on page 5](#) for more information.

## Local exhaust

The installation of localized exhaust for a printer enables the capture of airborne contaminants and heat near their source of generation, and subsequently allows their efficient removal from the building through contained and relatively low-volume air flow.

A workspace health and safety professional can provide guidance on the design and use of this auxiliary ventilation equipment.

## Local exhaust specifications

The local exhaust should meet certain specifications in order to improve comfort without affecting printing operation conditions.

- Airflow should be between 100 and 150 m<sup>3</sup>/h.
- Pressure should be between 0 Pa and –10 Pa.

These parameters should be measured 15 cm downstream from the printer's heat-extractor exhaust.

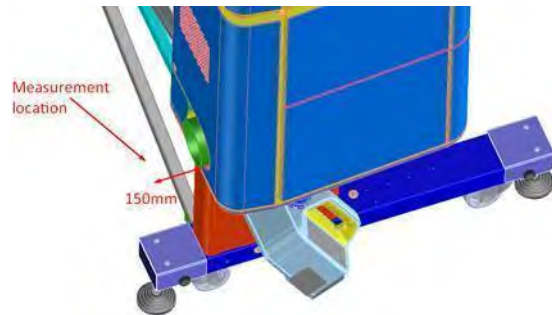

## Air conditioning

In addition to fresh air ventilation, to avoid health hazards, consider maintaining workplace ambient levels by ensuring the climatic operating conditions.

See [Environmental specifications on page 4](#) to avoid operator discomfort and equipment malfunction. Air conditioning in the work area should take into account that the equipment produces heat. Typically, the printer's power dissipation is 3 kW (10.2 kBTU/h).

Air conditioning should meet local environmental, health, and safety (EHS) guidelines and regulations.

**CAUTION:** The air conditioning units should not blow air directly onto the printer.

## Designing the optimal print production area

You need enough space around your printer to operate and maintain it comfortably.

Ensure that you have enough space to perform the following tasks:

- Print
- Replace a substrate roll
- Service the printer or replace printer components
- Ensure the printer is well ventilated

**Table 2-4** Space required for printer

Width	2100 mm (82.7 in)
Length	2793 mm (110.0 in)

**Table 2-4 Space required for printer (continued)**

Height	1970 mm (77.6 in)
--------	-------------------

The optimum production space needed is:

- 100 mm (4 in) margin at the rear and sides of the printer.
- 900 mm (3 ft) at the front of the printer.

## RIP workstation characteristics

You need to identify a suitable computer to run your RIP software.

Each RIP has specific requirements. Check with your RIP vendor to find out the requirements for the computer that you'll be using for the RIP station. See <http://www.hp.com/go/latexrips> for a complete list of certified RIP stations available for this printer. Make sure that the RIP station is fully functional and ready for installation.

## Networking

Your printer needs to be connected to a suitable network.

You are responsible for all networking requirements, and you must complete the following tasks:



**NOTE:** In order to perform remote support, the printer must have access to the Internet using the LAN connection.

- Have a Gigabit Ethernet network ready for the day of installation.
- Provide a CAT-6 LAN cable to connect the printer to your LAN and RIP workstation.
- Provide a Gigabit Ethernet switch.

For full use of your printer's features, it should be connected to the Internet. Most unmanaged networks are directly connected to the Internet. However, some networks require a Web proxy. A proxy is a server that acts as an intermediary between computers on your local network and servers on the Internet. Before setting up the printer, check whether your network requires a Web proxy.

To check this, open Internet Explorer or Safari on any computer within your network, and browse to the <http://hp.com> site. If you cannot connect to hp.com, your network does not have Internet access and you need to consult with your IT provider on how to configure Internet access. If you can connect to hp.com, you can check the browser settings for proxy configuration as follows:

- For Internet Explorer, go to **Tools > Internet Options > Connections > Local Area Network (LAN) Settings**. In the "Proxy server" part of the window, if the **Use a proxy server** box is unchecked, you do not need a Web proxy. If it is checked, make a note of the Address and Port settings in the main window, or in the HTTP part of the Advanced settings window.
- For Safari, go to **Preferences > Advanced > Proxies > Change Settings**. If the **Web Proxy (HTTP)** box is unchecked, you do not need a Web proxy. If it is checked, make a note of the Web Proxy Server name (before the ":") and port (after the ":").
- Proxy server names typically look like "proxy.mycompany.com", and the proxy port is typically 80, but details are network-dependent.

If you are unable to determine whether you need a Web proxy or how to configure it, consult your network administrator or Internet Service Provider. If in doubt, you probably do not need a Web proxy.

## Printing supplies

Some printing is done during the printer installation process, which requires some printing supplies (ink and substrate).

The following supplies should be purchased in addition to the printer and should be available on the day of installation:

- Eight HP 832 Eco-Carton ink cartridges, one for each color (black, cyan, magenta, yellow, light cyan, light magenta, optimizer, and overcoat), for 700 series printers.
- Additionally, two HP 832 white Eco-Carton ink cartridges for 700 W printers.
- Eight 3 liter HP 873 Eco-Carton ink cartridges, one for each color (black, cyan, magenta, yellow, light cyan, light magenta, optimizer, and overcoat), for 800 series printers.
- Additionally, two 3 liter HP 873 white Eco-Carton ink cartridges for 800 W printers.
- At least one roll of substrate to perform calibrations and printhead alignment during printer setup.

## Return the site preparation checklist

The checklist must be completed and returned to your reseller or service representative a minimum of two weeks before the day of installation.

See [Site preparation checklist on page 15](#).



**NOTE:** Any delays during installation that are caused by an unprepared site will be charged to the customer. Take care that your site is properly prepared to ensure a smooth and easy installation.

## Electrical configuration

Your printer requires the some electrical components to be supplied and installed by the customer, according to the Electrical Code requirements of the local jurisdiction of the country where the equipment is installed.



**NOTE:** If configuration of the building electrical system used to power the printer needs to be modified to meet printer requirements, an electrician is required. Make sure that your electrician is appropriately certified according to local regulations and supplied with all the information regarding the electrical configuration.

Components required:

### Single-phase power

These are the printer's power-supply requirements.

**Table 2-5 Power specifications**

	HP Latex 700 series	HP Latex 800 series
Number of power cords		2
Input voltage	200–240 V (two wires and protective earth)	

**Table 2-5 Power specifications (continued)**

	HP Latex 700 series	HP Latex 800 series
Input frequency	50 / 60 Hz	
Maximum load current (per power cord)	Printer: 13 A	Printer: 16 A
	Curing: 9 A	Curing: 16 A
Printing power consumption *	1.5 – 2.6 kW (3.6 kW peak)	1.8 – 2.8 kW (5.0 kW peak)
Power consumption in ready mode	95 W	105 W

\* Final printing power consumption may be affected by room and printing temperature, input voltage, and other factors.

## Circuit breakers

These are the printer's circuit-breaker requirements.



**NOTE:** The circuit breakers must meet the requirements of the printer and should be in accordance with the Electrical Code requirements of the local jurisdiction of the country where the equipment is installed.

**Table 2-6 Dedicated lines per SKU**

Characteristic	Specification
Dedicated line	HP Latex 800 series: Required. See <a href="#">Single-phase power on page 8</a> . HP Latex 700 series: Not required. Do not overload lines. See <a href="#">Single-phase power on page 8</a> .
Branch circuit breaker	2 poles, 16 or 20 A according to local laws and printer maximum load current
Residual current circuit breaker, also known as Ground Fault Circuit Interrupter (GFCI)	Required. 2 poles, 30 mA residual, at least 20 A capacity.

Figure 2-3 Electrical configuration diagram (for reference only)

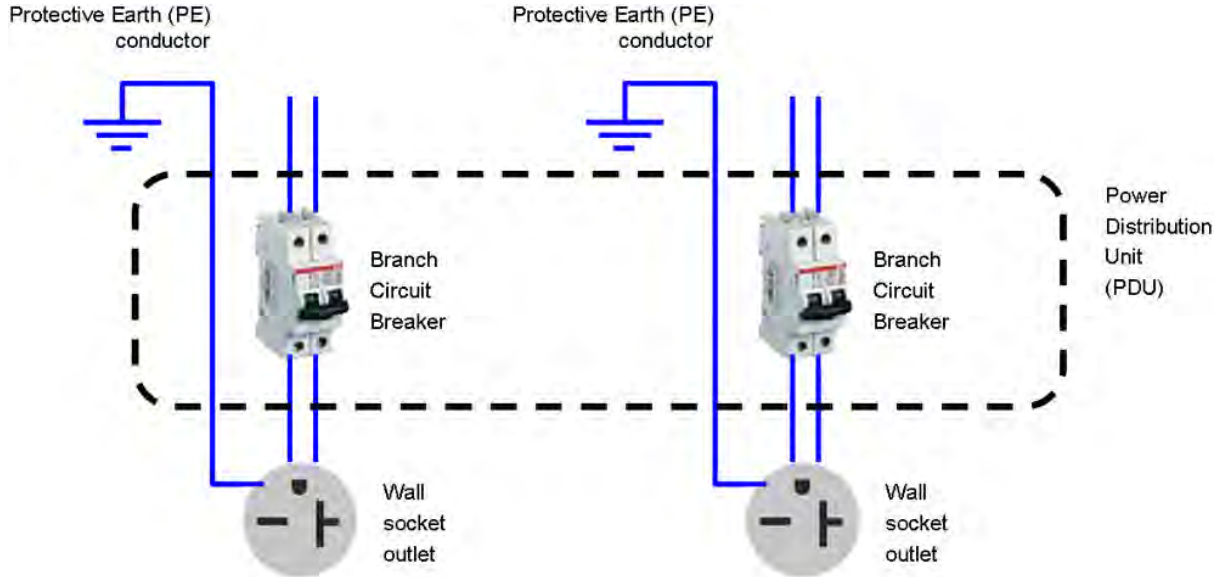

**NOTE:** The Power Distribution Unit (PDU) must be rated to meet the power requirements of the printer, and shall be in accordance with the Electrical Code requirements of the local jurisdiction of the country where the equipment is installed.

**WARNING!** Do not use a power strip (relocatable power tap) to connect both power cords.

## Wall receptacles and power cords

The printer's power cord and plug vary in detail from country to country; the wall socket must be suitable for the plug and for the printer.

Two power cords are provided with your printer, according to the printer's electrical specifications. If those cords do not reach your PDU and/or UPS, a certified electrician must install suitable extension cables on the day of installation.

To make sure you have the right wall socket outlets (wall receptacles) ready for installation, check the following:

- The wall socket outlets must be suitable for **printer input ratings**. See [Single-phase power on page 8](#).
- The wall socket outlets must be suitable for the **power cord plug type** used in the country of installation. The [Table 2-7 Power cord specifications for the HP Latex 700 Printer series on page 11](#) list examples of the power cords and the plugs provided with the printer according to the country. To make sure you have the right wall receptacle, find your country in the appropriate table and check the **plug type**.





**WARNING!** Use only the power cord supplied by HP with the printer. Do not use a power strip (relocatable power tap) to connect both power cords. Do not damage, cut, or repair the power cord. With a damaged power cord, there is a risk of fire and electric shock. Always replace a damaged power cord with an HP-approved power cord.

The following tables list examples of the power cords provided with the printer.





**Table 2-7** Power cord specifications for the HP Latex 700 Printer series

Country	HP part number	Length	Plug type	Plug	Rated current	Voltage
EU, Russia, Korea, Indonesia	8120-6352	2.5 m	CEE 7-VII		16 A	250 V
Denmark	8121-1077	2.5 m	DK 2-5 A		13 A	250 V
Israel	8121-1010	2.5 m	SI 32 90-DEG		16 A	250 V
South Africa	8121-0915	2.5 m	SABS 164		16 A	250 V
Switzerland	8121-6897	4.5 m	IEC 60309, 240 V, 16 A, 2L+PE		16 A	250 V
Argentina	8121-0925	2.5 m	IRAM 2073, 250 V, 20 A		20 A	250 V
U.K., Singapore, Hong Kong, Middle East	8120-6898	2.5 m	BS 1363/A (13 A fused)		13 A	250 V
US, Canada, Mexico/Japan, Philippines/Thailand, Middle East (Optional)	8120-6360	2.5 m	NEMA 6-20P, 240 V, 20 A (non-locking)		20 A	250 V
Brazil	8121-1101	2.5 m	NBR 14136		16 A	250 V
Chile, Uruguay	8121-0923	2.5 m	CEI 23-50		16 A	250 V

**Table 2-7** Power cord specifications for the HP Latex 700 Printer series (continued)

Country	HP part number	Length	Plug type	Plug	Rated current	Voltage
Australia, New Zealand	8120-6351	2.5 m	AS/NZS 3112 (15 A)		15 A	250 V
India	8121-1074	2.5 m	IS 1293		15 A	250 V
China	8121-0924	2.5 m	GB2099, GB 1002 (16 A)		16 A	250 V
Taiwan	8121-1033	2.5 m	CNS 690 Type 2(4)		15 A	250 V

**Table 2-8** Power cord specifications for the HP Latex 800 Printer series



Country	HP part number	Length	Plug type	Plug	Rated current	Voltage
US, Canada, Mexico, Japan, Philippines, Thailand	8120-6360	2.5 m	NEMA 6-20P, 240 V, 20 A (non-locking)		20 A	250 V
International	8120-6897	4.5 m	IEC 60309, 240 V, 16 A, 2L+PE		16 A	250 V
Argentina	8121-0925	2.5 m	IRAM 2073, 250 V, 20 A		20 A	250 V
Brazil	8121-1101	2.5 m	NBR 14136 Fig 7, 250V, 16A		16 A	250 V
Chile	8121-0923	2.5 m	IEC 23-50, 250 V, 16 A		16 A	250 V



**Table 2-8** Power cord specifications for the HP Latex 800 Printer series (continued)

Country	HP part number	Length	Plug type	Plug	Rated current	Voltage
Singapore, Hong Kong	8120-6360	4.5 m	NEMA 6-20P, 240 V, 20 A (non-locking)		20 A	250 V

**Table 2-9** Appliance coupler (printer connection)

Country	Appliance coupler (power cable)	Appliance coupler inlet (printer)
All	Detachable terminal as per IEC60320-1 C19 (squared type)	Detachable inlet as per IEC60320-1 C20 (squared type)
	 <b>C19</b>	 <b>C20</b>

 **NOTE:** Place the printer close enough to the wall receptacle that the plug can be plugged and unplugged easily.

## Powerline disturbances

As with all computer and electronic equipment, reliable operation of your printer depends on the availability of relatively noise-free AC power.

- In order to ensure optimum performance and reliability, your printer should be protected from variations in line voltage. Lightning, line faults, or the switching of lighting or machinery can generate line transients that far exceed the peak value of the applied voltage. If not reduced, these microsecond pulses can disrupt system operation and damage the printer.
- It is recommended to include overvoltage (OVP) and transient protection in the power supply to the printer.
- All electrical noise-generating equipment, such as fans, fluorescent lighting, and air-conditioning systems, should be kept separate from the power source used for your printer.

## Grounding

The printer must be connected to a good-quality ground line in order to avoid electrical risk. Please note your obligation to comply with the Electrical Code requirements of the local jurisdiction of the country where the equipment is installed.

The following grounding tasks must be fulfilled to meet the site preparation requirements:

- Grounding wires must be insulated and at least equal in size to the phase conductors.
- Ground impedance must be less than 0.5  $\Omega$  or comply with the Electrical Code requirements of the local jurisdiction of the country where the equipment is installed.

# 3 Site preparation checklist

These questions must be answered before the printer is delivered.

**Table 3-1 Safety requirements**

Question	Yes	No	Comments
Do those who will operate the printer have the technical training and experience necessary to be aware of hazards to which they may be exposed in performing a task, and to take appropriate measures to minimize the risks?	<input type="checkbox"/>		(Required)
Is there an emergency exit in the print production area, with easy access and free from any obstruction?	<input type="checkbox"/>	<input type="checkbox"/>	

**Table 3-2 Electrical installation requirements**

Question	Yes	No	Comments
Is the electrician aware of all requirements and specifications highlighted in this guide?	<input type="checkbox"/>		(Required)
Is the single-phase line voltage inside the specified voltage range, 200–240 V?	<input type="checkbox"/>		(Required) Specify nominal mains voltage:
Are there the dedicated lines to connect printer's power cords? <b>NOTE:</b> Do not use a power strip (relocatable power tap) to connect both power cords.	<input type="checkbox"/>		(Required)
Have branch circuit breakers (2 poles, 16 A/20 A general) been correctly installed for each dedicated line?	<input type="checkbox"/>		(Required)
Have the Residual Current Circuit Breaker (also known as Ground Fault Circuit Interrupter) (2 poles, 30 mA residual, at least 20A capacity) been correctly installed if required or recommended?	<input type="checkbox"/>		(Required)
Is the Power Distribution Unit (PDU) correctly installed?	<input type="checkbox"/>		(Required)
Are the grounding conductors properly installed for each wall receptacle (wall socket)?	<input type="checkbox"/>		(Required)
Are the wall receptacles (wall sockets) suitable for the power cord plug type provided by HP?	<input type="checkbox"/>		(Required)
Are the wall receptacles (wall sockets) and electrical installation suitable for the printer's rated current ? <b>NOTE:</b> See <a href="#">Wall receptacles and power cords on page 10</a> and <a href="#">Single-phase power on page 8</a> for further information.	<input type="checkbox"/>		(Required)
Are the wall receptacles (wall sockets) placed close enough to the printer that the plugs can be plugged and unplugged easily?	<input type="checkbox"/>		(Required)

**Table 3-3 Electrical configuration requirements**

Question	Yes	No	Comments
Do you need an Uninterrupted Power Supply (UPS) or step-up transformer? If so, is it correctly installed?	<input type="checkbox"/>	<input type="checkbox"/>	

**Table 3-4 Networking and computer requirements**

Question	Yes	No	Comments
Is the RIP computer and software ready for installation?	<input type="checkbox"/>	<input type="checkbox"/>	
Have network connections been supplied as per spec?	<input type="checkbox"/>	<input type="checkbox"/>	
Do you need a web proxy? If so, write down proxy server name and port.	<input type="checkbox"/>	<input type="checkbox"/>	
Do you have a color sensor that is compatible with your RIP?	<input type="checkbox"/>	<input type="checkbox"/>	
Do you have a LAN cable long enough to connect the printer to the network?	<input type="checkbox"/>	<input type="checkbox"/>	

**Table 3-5 Environmental requirements**

Question	Yes	No	Comments
Have the temperature and humidity requirements been satisfactorily met in the print production area?	<input type="checkbox"/>	<input type="checkbox"/>	
Have the temperature and humidity requirements been satisfactorily met in the storage area?	<input type="checkbox"/>	<input type="checkbox"/>	
Is the print production area free from dirt and dust?	<input type="checkbox"/>	<input type="checkbox"/>	
Does the print production area have sufficient lighting?	<input type="checkbox"/>	<input type="checkbox"/>	
Have you checked and met the ventilation requirements specified in the site preparation guide?	<input type="checkbox"/>		(Required)

**Table 3-6 Other requirements**

Question	Yes	No	Comments
Have you arranged for supplies such as substrate and Eco-Carton ink cartridges to be available on the day of installation?	<input type="checkbox"/>	<input type="checkbox"/>	
Have you met the requirements specified in this guide?	<input type="checkbox"/>		(Required)

**Table 3-7 Customer information**

Please enter the requested information
Date of site preparation completion
Site preparation guide edition number or copyright date
Customer signature

Table 3-7 Customer information (continued)

---

Please enter the requested information

---

---