



# HP Latex 300 Printer Series

User Guide

Edition 4

© 2016, 2017, 2018 HP Development Company, L.P.

#### **Legal notices**

The information contained herein is subject to change without notice.

The only warranties for HP products and services are set forth in the express warranty statements accompanying such products and services. Nothing herein should be construed as constituting an additional warranty. HP shall not be liable for technical or editorial errors or omissions contained herein.

#### **Trademarks**

Microsoft® and Windows® are U.S. registered trademarks of Microsoft Corporation.

---

# Table of contents

<b>1 Introduction .....</b>	<b>1</b>
Welcome to your printer .....	2
Printer models .....	2
Documentation .....	3
Safety precautions .....	3
Main printer components .....	8
Front panel .....	11
HP Latex Mobile .....	20
Embedded Web Server .....	22
Connectivity and software instructions .....	28
Advanced network configuration .....	30
Turn the printer on and off .....	36
Restart the printer .....	37
<b>2 Useful links .....</b>	<b>38</b>
When you need help .....	38
<b>3 Handle the substrate and troubleshoot substrate issues .....</b>	<b>40</b>
Overview .....	42
Porous substrates .....	46
Load a roll onto the spindle .....	47
Load a roll into the printer .....	52
Ink collector (365 and 375 only) .....	55
Loading accessory (365 and 375 only) .....	59
Assisted manual load .....	63
Edge holders .....	65
Load a cut sheet into the printer .....	67
Unload a roll from the printer .....	68
Take-up reel .....	69
Double-sided printing (365 and 375 only) .....	77
View information about the substrate .....	78
Change substrate width and right edge position .....	79
Substrate length tracking .....	79
Cut substrate .....	79

Bypass job start safety .....	80
Store the substrate .....	80
Substrate cannot be loaded successfully .....	80
Substrate is mispositioned .....	81
Substrate has jammed .....	81
Substrate is deformed or wrinkled .....	84
Substrate has shrunk or expanded .....	84
Substrate has bow deformation .....	85
Substrate is sticky and causes smears and crashes .....	86
Automatic cutter does not work .....	86
Take-up reel substrate jam .....	86
Take-up reel does not wind .....	86
<b>4 Substrate settings .....</b>	<b>88</b>
Substrate presets .....	89
Online search .....	89
HP Media Locator .....	91
Generic presets .....	92
Clone a substrate preset .....	92
Modify a substrate preset .....	93
Add a new substrate .....	94
Delete a substrate preset .....	98
Faster printing .....	98
Color calibration .....	99
Color consistency between different printers (365, 375) .....	103
ICC profiles .....	103
Improve color consistency when tiling .....	104
<b>5 Troubleshoot print-quality issues .....</b>	<b>107</b>
General printing advice .....	108
Quick Solutions application (365 and 375 only) .....	108
Improve print quality .....	109
Most-common print-quality problems .....	115
<b>6 Ink system .....</b>	<b>125</b>
Ink cartridges .....	125
Printheads .....	125
Maintenance cartridge .....	126
Safe mode .....	127
<b>7 Hardware maintenance .....</b>	<b>128</b>
Ink system tips .....	129
Maintain the ink cartridges .....	129

Replace an ink cartridge .....	129
Cannot insert an ink cartridge .....	133
Clean (recover) the printheads .....	133
Align the printheads .....	134
Front panel recommends reseating or replacing a printhead .....	136
Replace a printhead .....	136
Cannot insert a printhead .....	142
Clean the electrical connections on a printhead .....	143
Replace the maintenance cartridge .....	147
Cannot insert the maintenance cartridge .....	150
Clean and lubricate the carriage rod .....	150
Clean the encoder strip .....	152
Clean the platen .....	153
Clean the substrate-advance sensor window .....	154
Clean the exterior of the printer .....	155
Move or store the printer .....	155
Service maintenance .....	156
<b>8 Firmware update .....</b>	<b>157</b>
Firmware update using a USB flash drive .....	157
Firmware update using the Embedded Web Server .....	158
Automatic firmware updates .....	158
<b>9 Accessories .....</b>	<b>159</b>
Order ink supplies .....	159
Order accessories .....	161
<b>10 Troubleshoot other issues .....</b>	<b>162</b>
Printer cannot get an IP address .....	163
Cannot access the Embedded Web Server .....	163
Printer is not printing .....	163
The software program slows down or stalls while generating the print job .....	164
Printer seems slow .....	164
Communication failures between computer and printer .....	165
Cannot connect to services such as firmware update, online search, or the Printer Data Sharing Agreement ...	165
Front-panel error codes .....	166
<b>11 Printer specifications .....</b>	<b>172</b>
Functional specifications .....	172
Physical specifications .....	174
Memory specifications .....	174
Power specifications .....	174
Ecological specifications .....	174

Environmental specifications .....	175
Acoustic specifications .....	175
Appendix A Summary of common printing problems .....	176
Glossary .....	179
Index .....	182

---

# 1 Introduction

- [Welcome to your printer](#)
- [Printer models](#)
- [Documentation](#)
- [Safety precautions](#)
- [Main printer components](#)
- [Front panel](#)
- [HP Latex Mobile](#)
- [Embedded Web Server](#)
- [Connectivity and software instructions](#)
- [Advanced network configuration](#)
- [Turn the printer on and off](#)
- [Restart the printer](#)

## Welcome to your printer

Your printer is a color inkjet printer designed for printing high-quality images on flexible substrates. Some major features of the printer are shown below:

- Environmentally friendly, odorless, aqueous latex inks in six colors plus optimizer
- 775 ml ink cartridges (3-liter cartridges for the 375 printer)
- Sharpest print quality, smooth transitions, and fine details with 1200 real dpi
- Consistent and repeatable print quality at every print speed
- Prints are completely dry and ready for finishing and delivery
- Print on a wide range of substrates—including most low-cost, uncoated, solvent-compatible substrates
- A range of HP recyclable substrates is available
- Consider un-laminated use with scratch resistance comparable to hard solvent inks on SAV and PVC banners
- Durable prints with outdoor display permanence up to three years unlaminated, five years laminated
- Hundreds of ready-made substrate presets easily available

To send print jobs to your printer, you will need Raster Image Processor (RIP) software, which should be run on a separate computer. RIP software is available from various different companies.

## Printer models

	HP Latex 315	HP Latex 335	HP Latex 365	HP Latex 375
Supplied with the printer		HP Latex 64-in Take-Up Reel	HP Latex 64-in Take-Up Reel	HP Latex 64-in Take-Up Reel
	HP Latex 54-in Printer 2-in Spindle (including 2- to 3-in spindle adaptor)	HP Latex 64-in Printer 2-in Spindle (including 2- to 3-in spindle adaptor)	HP Latex 64-in Printer 3-in Spindle	HP Latex 64-in Printer 3-in Spindle
			HP Latex Substrate-Loading Accessory	HP Latex Substrate-Loading Accessory
	HP Latex 300/500 User Maintenance Kit	HP Latex 300/500 User Maintenance Kit	HP Latex 300/500 User Maintenance Kit	HP Latex 300/500 User Maintenance Kit
	FlexiPRINT HP Basic Edition	FlexiPRINT HP Basic Edition		
			HP Latex 300/500 Ink Collector (including output platen protector)	HP Latex 300/500 Ink Collector (including output platen protector)
Optional accessories	HP Latex 300 54-in Take-Up Reel (including 2-in reel with 3-in adaptor and Variable Front Tension Kit)			
	HP Latex 54-in Printer 2-in Spindle (including 2- to 3-in spindle adaptor)	HP Latex 64-in Printer 2-in Spindle (including 2- to 3-in spindle adaptor)	HP Latex 64-in Printer 2-in Spindle (including 2- to 3-in spindle adaptor)	HP Latex 64-in Printer 2-in Spindle (including 2- to 3-in spindle adaptor)
		HP Latex 64-in Printer 3-in Spindle	HP Latex 64-in Printer 3-in Spindle	HP Latex 64-in Printer 3-in Spindle



	HP Latex 315	HP Latex 335	HP Latex 365	HP Latex 375
	HP Latex 300/500 User Maintenance Kit	HP Latex 300/500 User Maintenance Kit	HP Latex 300/500 User Maintenance Kit	HP Latex 300/500 User Maintenance Kit
			HP Latex 300/500 Ink Collector (including the consumable parts)	HP Latex 300/500 Ink Collector (including the consumable parts)
Consumables	HP 831 Latex Printheads (1 set included in box)	HP 831 Latex Printheads (1 set included in box)	HP 831 Latex Printheads (1 set included in box)	HP 831 Latex Printheads (1 set included in box)
	HP 831 Latex Ink Cartridges	HP 831 Latex Ink Cartridges	HP 831 Latex Ink Cartridges	HP 831 Latex Ink Cartridges
				HP 871 3-liter Ink Cartridges
	HP 831 Latex Maintenance Cartridge (1 included in box)	HP 831 Latex Maintenance Cartridge (1 included in box)	HP 831 Latex Maintenance Cartridge (1 included in box)	HP 831 Latex Maintenance Cartridge (1 included in box)

## Documentation

The following documents can be downloaded from <http://www.hp.com/go/latex300/manuals/>:

- Introductory information
- Printer assembly instructions
- User guide
- Legal information
- Limited warranty

The Quick Response (QR) code images found in some parts of this user guide provide links to additional video explanations of particular topics. For an example of such an image, see [Main printer components on page 8](#).

## Safety precautions

Before using your printer, read the following safety precautions to make sure you use the equipment safely.

You are expected to have the appropriate technical training and experience necessary to be aware of hazards to which you may be exposed in performing a task, and take appropriate measures to minimize the risks to yourself and to other people.

## General safety guidelines

There are no operator-serviceable parts inside the printer except those covered by HP's Customer Self Repair program (see <http://www.hp.com/go/selfrepair/>). Refer servicing of other parts to qualified service personnel.

Turn off the printer and call your service representative in any of the following cases:

- The power cord or plug is damaged.
- The curing enclosures are damaged.
- The printer has been damaged by an impact.
- There is any mechanical or enclosure damage.
- Liquid has entered the printer.

- There is smoke or an unusual smell coming from the printer.
- The printer has been dropped or the curing module has been damaged.
- The printer is not operating normally.

Turn off the printer in either of the following cases:

- During a thunderstorm
- During a power failure

Take special care with zones marked with warning labels.

## Electrical shock hazard

---

 **WARNING!** The internal circuits of curing zones, output drier, print-zone heaters, and built-in power supplies operate at hazardous voltages capable of causing death or serious personal injury.

---

The printer uses two power cords. Unplug both power cords before servicing the printer.

To avoid the risk of electric shock:

- The printer must be connected to earthed mains outlets only.
- Do not attempt to dismantle the curing modules.
- Do not remove or open any other closed system covers or plugs.
- Do not insert objects through slots in the printer.

## Heat hazard

The curing subsystems of the printer operate at high temperatures and can cause burns if touched. To avoid personal injury, take the following precautions.

- Do not touch the internal enclosures of the printer's curing zones.
- Let the printer cool down when accessing the internal curing zone and output platen in case of a substrate jam.
- Let the printer cool down before performing some maintenance operations.

## Fire hazard

The curing subsystems of the printer operate at high temperatures.

To avoid the risk of fire, take the following precautions.

- The customer is responsible for meeting the printer's requirements and the Electrical Code requirements according to the local jurisdiction of the country where the equipment is installed. Use the power supply voltage specified on the nameplate.
- Connect the power cords to dedicated lines, each protected by a branch circuit breaker according to the information detailed in the site preparation guide. Do not use a power strip (relocatable power tap) to connect both power cords.
- Use only the power cords supplied by HP with the printer. Do not use a damaged power cord. Do not use the power cords with other products.
- Do not insert objects through slots in the printer.

- Take care not to spill liquid on the printer. After cleaning, make sure all components are dry before using the printer again.
- Do not use aerosol products that contain flammable gases inside or around the printer. Do not operate the printer in an explosive atmosphere.
- Do not block or cover the openings of the printer.
- Do not attempt to dismantle or modify the curing modules.
- Ensure that the operating temperature of the substrate recommended by the manufacturer is not exceeded. If this information is not available, ask the manufacturer. Do not load substrates that cannot be used at an operating temperature above 125°C (257°F).
- Do not load substrates with auto-ignition temperatures below 250°C (482°F). If this information is not available, printing must be supervised at all times. See note below.



**NOTE:** Test method based on EN ISO 6942:2002; *Evaluation of materials and material assemblies when exposed to a source of radiant heat, method B*. The test conditions, to determine the temperature when the substrate starts ignition (either flame or glow), were: Heat flux density 30 kW/m<sup>2</sup>, copper calorimeter, K type thermocouple.

## Mechanical hazard

The printer has moving parts that could cause injury. To avoid personal injury, take the following precautions when working close to the printer.

- Keep your clothing and all parts of your body away from the printer's moving parts.
- Avoid wearing necklaces, bracelets, and other hanging objects.
- If your hair is long, try to secure it so that it will not fall into the printer.
- Take care that sleeves or gloves do not get caught in the printer's moving parts.
- Avoid standing close to the fans, which could cause injury and could also affect print quality (by obstructing the air flow).
- Do not touch gears or moving rolls during printing.
- Do not operate the printer with covers bypassed.

## Light radiation hazard

Light radiation is emitted from the illumination of the print zone. This illumination is in compliance with the requirements of the exempt group of IEC 62471:2006, *Photobiological safety of lamps and lamp systems*. However, you are recommended not to look directly at the LEDs while they are on. Do not modify the module.

## Chemical hazard

See the safety data sheets available at <http://www.hp.com/go/msds> to identify the chemical ingredients of your consumables. Sufficient ventilation should be provided to ensure that potential airborne exposure to these substances is adequately controlled. Consult your usual air-conditioning or EHS specialist for advice on the appropriate measures for your location. For more detailed information, see the "Ventilation" and "Air conditioning" sections of the site preparation guide, available from <http://www.hp.com/go/latex300/manuals/>.

## Ventilation

Ensure that the room in which the system is installed meets local environmental, health, and safety (EHS) guidelines and regulations.

Adequate ventilation needs to be provided to ensure that potential exposure is adequately controlled. Consult the Safety Data Sheets available at <http://www.hp.com/go/msds> to identify chemical ingredients of your ink consumables. Levels of certain substances in your environment are dependent on workspace variables you control, such as room size, ventilation performance, and duration of equipment use. Consult your EHS specialist for advice on the appropriate measures for your location.

## Air conditioning

In addition to fresh air ventilation, to avoid health hazards, consider maintaining workplace ambient levels by ensuring the climatic operating conditions specified in this document (see [Environmental specifications on page 175](#)) to avoid operator discomfort and equipment malfunction. Air conditioning in the work area should take into account that the equipment produces heat. Typically, the printer's power dissipation is:

- 2.2 kW (7.5 kBTU/h) for HP Latex 315 printers
- 2.6 kW (8.9 kBTU/h) for HP Latex 335 printers
- 4.6 kW (15.7 kBTU/h) for HP Latex 365 and 375 printers

Air conditioning should meet local environmental, health, and safety (EHS) guidelines and regulations.

---

**⚠ CAUTION:** The air conditioning units should not blow air directly onto the printer.

---

## Heavy substrate hazard

Special care must be taken to avoid personal injury when handling heavy substrates.

- Handling heavy substrate rolls may require more than one person. Care must be taken to avoid back strain and/or injury.
- Consider using a forklift, pallet truck, or other handling equipment.
- When handling heavy substrate rolls, wear personal protective equipment including boots and gloves.

## Ink handling

HP recommends that you wear gloves when handling ink system components.

## Warnings and cautions

The following symbols are used in this manual to ensure the proper use of the printer and to prevent the printer from being damaged. Follow the instructions marked with these symbols.

---

**⚠ WARNING!** Failure to follow the guidelines marked with this symbol could result in serious personal injury or death.





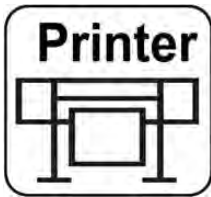

**⚠ CAUTION:** Failure to follow the guidelines marked with this symbol could result in minor personal injury or damage to the printer.



---

## Warning labels

Label	Explanation
	Printer label. To identify the printer's power cord.

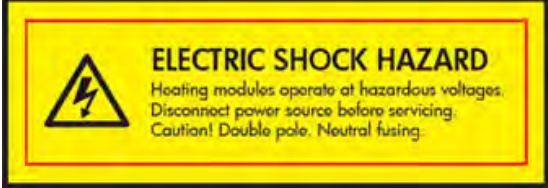
---

Label	Explanation
	<p>Curing label. To identify the curing power cord.</p>
	<p>Electric shock hazard. Heating modules operate at hazardous voltages. Disconnect power source before servicing.</p> <p><b>CAUTION:</b> Double pole. Neutral fusing.</p> <p>Equipment to be connected to earthed mains outlet only. Refer servicing to qualified service personnel. Disconnect all power cords before servicing. No operator serviceable parts inside the printer.</p> <p>Before starting, read and follow the operating and safety instructions. Ensure that the input voltage is within the printer's rated voltage range. The printer requires up to two dedicated lines.</p> <p>This label is located on the e-box.</p>
	<p>Risk of burns. Do not touch the curing zone or the output platen of the printer: they could be hot.</p> <p>This label is located on the front of the curing module.</p>
	<p>Risk of trapped fingers. Do not touch moving gears.</p> <p>These labels are located at the rear of the printer, one on the substrate input gear and one on the take-up reel gear (335, 365, and 375 only).</p>
	<p>Moving part. Keep away from the moving printhead carriage. When printing, the printhead carriage travels back and forth across the substrate.</p> <p>This label is located on the rear of the scan axis window, behind the plastic.</p>
	<p>You are recommended to wear gloves when handling the maintenance cartridge, the platen, or the ink collector.</p> <p>This label is located on the maintenance cartridge.</p>
	<p>Electric shock hazard. Heating modules operate at hazardous voltages. Disconnect all power sources before servicing.</p> <p>This label is located on the curing control PCA enclosure. For service personnel only.</p>

Label	Explanation
	<p>Electric shock hazard. The printer has two input power cords. Power supplies operate at hazardous voltages. Disconnect all power cords before servicing.</p> <p>This label is located internally (in the 365 and 375 only), close to the print-zone heating-coils enclosure between fans. For service personnel only.</p>
	<p>Hazardous moving parts. Rotating fan blades. Keep hands clear.</p> <p>These labels are located internally, close to the print-zone heating fans between fans (365 and 375 only), one near the vacuum fan and one near the aerosol fan. For service personnel only.</p>
	<p>Hazardous area. Heating modules operate at hazardous voltages.</p> <p>Electric shock hazard. Equipment has two input power cords. Disconnect all power cords before servicing. Power supplies operate at hazardous voltages.</p> <p>Double pole, neutral fusing.</p> <p>Equipment to be connected to earthed mains outlet only.</p> <p>This label is located in the scan and air-curtain heater control enclosure (365 and 375 only). For service personnel only.</p>

 **NOTE:** The final label position and its size on the printer may vary slightly, but should always be visible and close to the potential risk area.

## Main printer components



The above image is a QR code containing a link to a video; see [Documentation on page 3](#).

The following views of the printer illustrate its main components.

## Front view

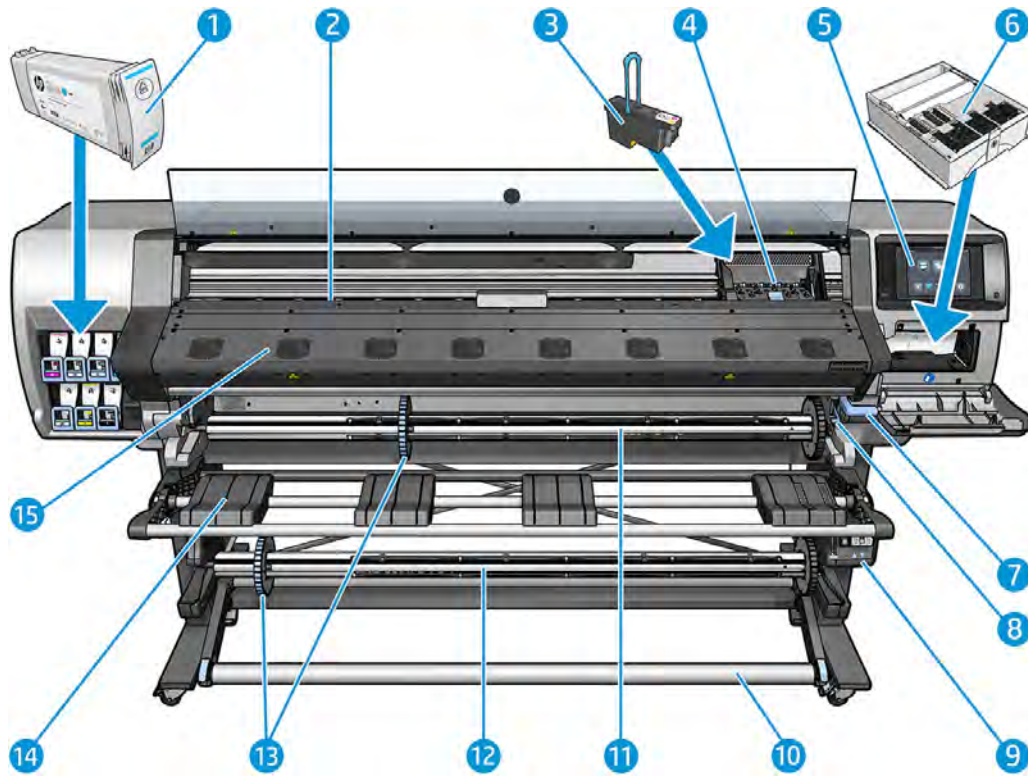

1. Ink cartridge
2. Platen
3. Printhead
4. Printhead carriage
5. Front panel
6. Maintenance cartridge
7. Substrate pinch lever
8. Spindle lock lever
9. Take-up reel motor
10. Tension bar
11. Spindle
12. Take-up reel
13. Spindle stop
14. Loading table
15. Curing module

## Rear view

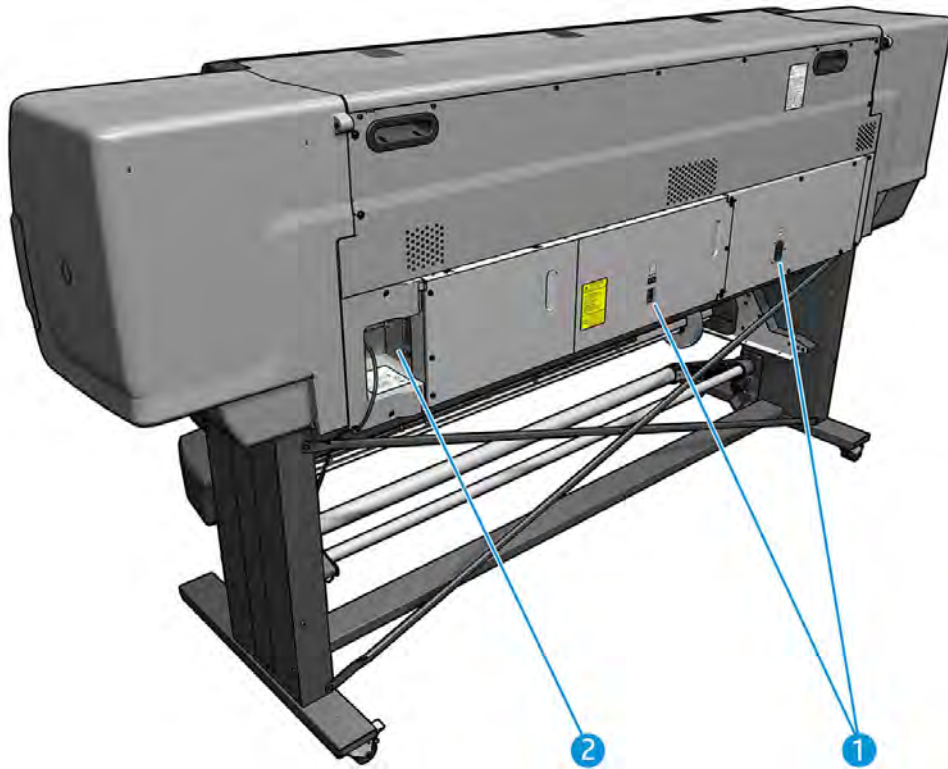

1. Power switch and power socket
2. Sockets for communication cables and optional accessories

## Take-up reel motor

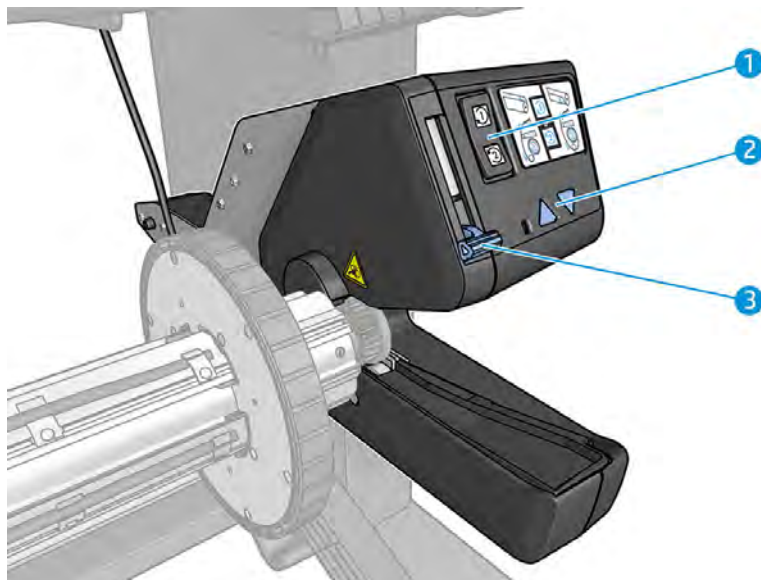

1. Winding-direction switch
2. Manual winding buttons
3. Take-up reel lever



## Loading accessory



The loading accessory helps you to load some substrate types that are difficult to load without it. See [Loading accessory \(365 and 375 only\) on page 59](#).

## Front panel

### Introduction to the front panel

The front panel is a touch-sensitive screen with a graphical user interface; it is located on the front right of the printer. It gives you complete control of your printer: from the front panel, you can view information about the printer, change printer settings, perform calibrations and tests, and so on. The front panel also displays alerts (warning and error messages) when necessary.

HP Latex 315/335 home screen

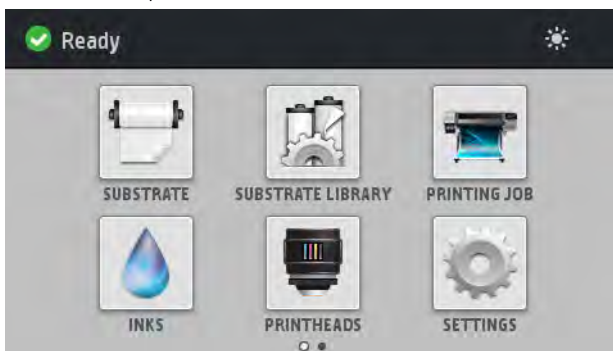

HP Latex 365/375 home screen

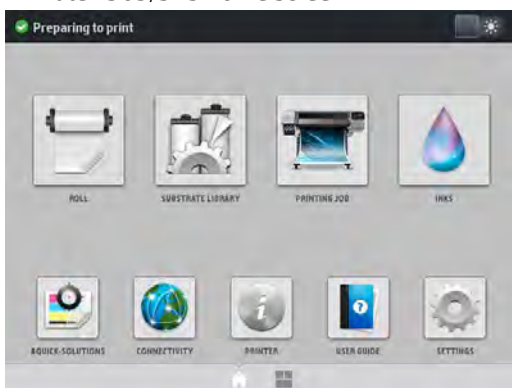



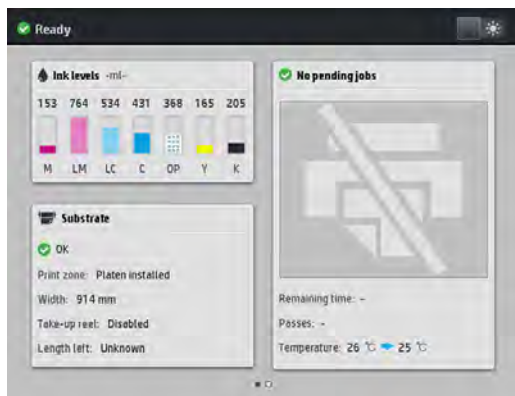



There is an alternative home screen that you can see by sliding your finger across the screen to the left. It summarizes the status of the ink cartridges, the substrate, and the current print job.



The front panel has a large central area to display dynamic information and icons. On the left and right sides you can see up to six fixed icons at different times. Normally they are not all displayed at the same time.

### Left and right fixed icons





- Press  to return to the home screen.
- Press  to view help about the current screen.
- Press  to go to the previous item.
- Press  to go to the next item.
- Press  to go back to the last-visited screen. This does not discard any changes made in the current screen.
- Press  to cancel the current process.



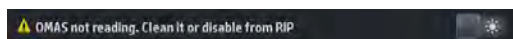

### Home screen dynamic icons

The following items are displayed only on the home screen.

- At the top left of the screen is a message showing the printer status or the most important current alert. Press this message to see a list of all current alerts, with an icon indicating the severity of each alert. You can press an alert to get help in solving the problem.



- At the top right, press  to turn on or off the print-zone illumination light.
- Press  to view substrate status and perform substrate-handling operations.
- Press  to open the Substrate Library and access the extensive online library of substrate presets.
- Press  to view information about the job that is currently printing.
- Press  to view ink-supply status and perform ink-cartridge and printhead operations.

- Press  to find quick solutions to printing problems.
- Press  to view network and Internet status and change related settings.
- Press  to view information about the printer.
- Press  for help.
- Press  to view and change printer settings in general.





If the printer is left idle for some time, it goes into sleep mode and switches off the front-panel display. To change the time that elapses before sleep mode, press , then **Setup > Front panel options > Sleep mode wait time**. You can set a time between 5 and 240 minutes; the default is 25 minutes.

The printer wakes from sleep mode and switches on the front-panel display whenever there is some external interaction with it.

Information about specific uses of the front panel can be found throughout this guide.

## Change the language of the front panel

Two methods are available to change the language that is used for the front-panel menus and messages.

- If you can understand the current front panel language, go to the front panel and press , then **Setup > Front panel options > Language**.
- If you cannot understand the current front panel language, start with the printer turned off. Turn it on. As soon as the  icon appears, press it for a few seconds. When all icons have appeared on the front panel, press  followed by . The front panel blinks briefly.

Whichever method you used, the language selection menu should now appear on the front panel.



Press the name of your preferred language.

## View or set the date and time

To view or set the printer's date and time, go to the front panel and press , then **Setup > Front panel options > Date and time options**.

## Set altitude

If your printer is operating at more than 500 m (1640 ft) above sea level, go to the front panel and press , then **Setup** > **Select altitude**, to tell the printer its operating altitude.

## Set time before standby

When there are no more jobs to print, or you want to pre-warm the printer (**Prepare printing** option in the RIP), the printer's curing heaters remain on for the specified time and temperature in case another job arrives or in case you need to avoid any print-quality problem that could be caused by an incorrect temperature in the print zone. To choose how long the heaters will stay on in this situation, go to the front panel and press , then **Substrate** > **Substrate handling options** > **Curing standby duration**. You can select from 5 to 120 minutes.

The curing temperature during this standby period is set automatically by the printer.

## Change the sleep mode setting

If the printer is left turned on but unused for a certain period of time, it automatically goes into sleep mode to save power. The default period of time it waits is 25 minutes. To change the time the printer waits before it goes into sleep mode, go to the front panel and press , then **Setup** > **Front panel options** > **Sleep mode wait time**. Enter in minutes the wait time that you want, then press **OK**.

## Change the loudspeaker volume

To change the volume of the printer's loudspeaker, go to the front panel and press , then **Setup** > **Front panel options** > **Speaker volume**, and select **Off**, **Low**, or **High**.

## Turn audio alerts on or off

To turn the printer's audio alerts on or off, go to the front panel and press , then **Setup** > **Front panel options** > **Enable audio alert** or **Disable audio alert**. By default, audio alerts are enabled.

## Change the front panel display brightness

To change the brightness of the front-panel display, press , then **Setup** > **Front panel options** > **Display brightness**, then select a value by moving the scroll bar. Press **OK** to save the value.

## Change the units of measurement

To change the units of measurement that appear on the front panel, press , then **Setup** > **Front panel options** > **Unit selection**, then **English** or **Metric**.

The units of measurement can also be changed in the Embedded Web Server. See [Access the Embedded Web Server on page 23](#).

## Restore factory settings

To restore the printer settings to their original values as set in the factory, go to the front panel and press , then **Setup** > **Resets** > **Restore factory settings**. This option restores all of the printer settings except the Gigabit Ethernet settings and substrate presets.

## Check printer status

The front panel and the Embedded Web Server both display the status of the printer, the loaded substrate, and the ink system.

## Check the status of the ink cartridges

You can see the ink levels in your ink cartridges by pressing  on the front panel's home screen.

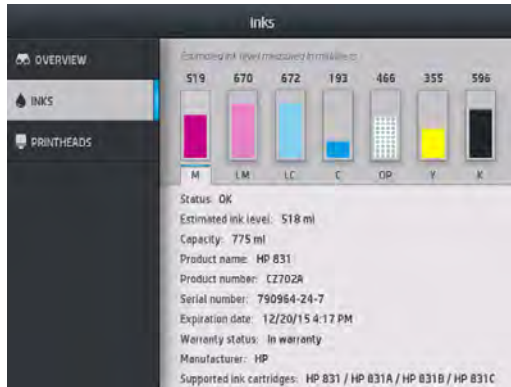

For more details about any particular ink cartridge, press the rectangle representing that cartridge. The following information is shown.

- Status
- Estimated ink level
- Capacity
- Product name
- Product number
- Serial number
- Expiration date
- Warranty status
- Manufacturer
- Supported ink cartridges

These are the possible ink cartridge status messages that you can see on the front panel:

- **OK:** The cartridge is working normally, with no known problems.
- **Missing:** There is no cartridge present, or it is not correctly connected to the printer.
- **Low:** The ink level is low.
- **Very low:** The ink level is very low.
- **Empty:** The cartridge is empty.
- **Reset:** You are recommended to remove the cartridge and then reinsert it.
- **Replace:** You are recommended to replace the cartridge with a new cartridge.
- **Expired:** The cartridge's expiration date has passed.

- **Incorrect:** The cartridge is not compatible with this printer. The message includes a list of compatible cartridges.
- **Non-HP:** The cartridge is used, refilled, or counterfeit.

You can also view the status of the ink cartridges in the Embedded Web Server. See [Access the Embedded Web Server on page 23](#).

## Check the status of a printhead

The printer automatically checks and services the printheads after each print. Follow these steps to get more information on your printheads.

1. On the front panel's home screen, press  (HP Latex 365 and 375) or the printhead icon (HP Latex 315 and 335).

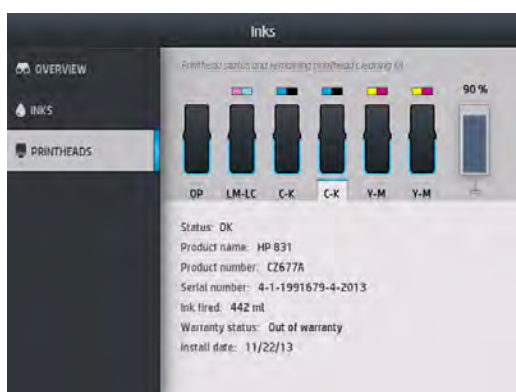

2. Select the printhead for which you want to see information.
3. The front panel shows the following information:
  - Status
  - Product name
  - Product number
  - Serial number
  - Ink fired
  - Warranty status
  - Install date

These are the possible printhead status messages that you can see on the front panel:

- **OK:** The printhead is working normally, with no known problems.
- **Missing:** There is no printhead present, or it is not correctly installed in the printer.
- **Reset:** You are recommended to remove the printhead and then reinsert it. If that fails, clean the electrical connections (see [Clean the electrical connections on a printhead on page 143](#)). If that fails, replace the printhead with a new printhead (see [Replace a printhead on page 136](#)).
- **Replace:** The printhead is failing. Replace the printhead with a working printhead (see [Replace a printhead on page 136](#)).

- **Replacement incomplete:** The printhead replacement process has not completed successfully; restart the replacement process and let it finish completely.
- **Remove:** The printhead is not a suitable type for use with your printer.
- **Non-HP ink:** Ink from a used, refilled, or counterfeit ink cartridge has passed through the printhead. See the limited warranty document provided with your printer for details of the warranty implications.

You can also use the Embedded Web Server to check the printhead status and the warranty status. See [Access the Embedded Web Server on page 23](#).

## Check the file system

It is possible to check the integrity of the file system on the printer's hard disk, and automatically correct any errors. You are recommended to do this about once every six months, or if you notice any trouble in accessing files on the hard disk.

To execute the file system check, go to the front panel and press , then **Preventive maint. tasks > File system check**.

If the printer is aware of damage to the file system, for instance after a severe software problem, it may start a file system check automatically. This can take about ten minutes.

## Printer alerts

The printer can communicate two types of alerts:

- **Errors:** When the printer is unable to print.
- **Warnings:** When the printer needs attention for an adjustment, such as a calibration, preventive maintenance, or ink cartridge replacement.
- **Advice:** When a firmware update is available or the downloaded firmware is ready to be installed.

Printer alerts appear in the front panel and in the Embedded Web Server.

- **Front-panel display:** The front panel shows the alerts in the upper left part of the screen (notification bar).



Only one alert is shown at a time. If you press the notification bar, all the current printer alerts are shown. The list of alerts can be folded back by pressing or sliding up the bottom row of the list.

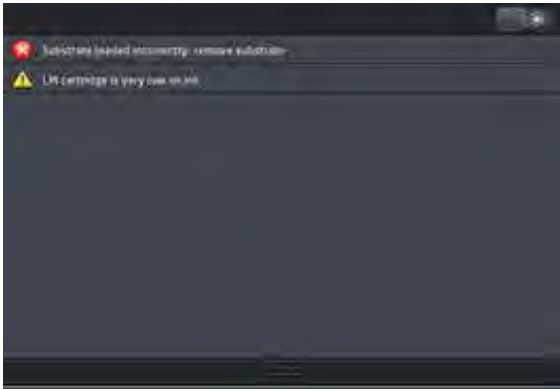

Clicking an alert opens the application that could help to resolve it. Firmware update advice is dismissed when entering the Printer application. Once dismissed, there won't be any reminder later on about the same advice (in the case of firmware updates, a new notification appears when there a new firmware release becomes available).

- **Embedded Web Server:** The Embedded Web Server shows only one alert at a time, which is judged to be the most important.

An alert may require you to perform a maintenance operation; see [Hardware maintenance on page 128](#).

The following alerts require a service engineer:

- **Service Maintenance Kit 1**
- **Service Maintenance Kit 2**
- **Service Maintenance Kit 3**

## Printer states

The printer may be in any one of the following states; some of them require waiting.

- **Ready (cold):** The printer is powered on but has not printed yet, and the heaters are not turned on.
- **Preparing to print:** The printer is warming up the heaters and preparing the printheads to print. This takes 1 to 6 min.
- **Ready for substrate**
- **Ready for side A/B**
- **Printing**
- **Printing side A/B**
- **Drying:** This takes 1.5 to 5 min.
- **Finishing:** The printer is cooling down and preparing for stand-by. This takes 0.5 to 5 min.

You can select continuous printing using certified RIP software. Without continuous printing, the printer cures each job separately and then winds the substrate back into the print zone before starting to print the next job in the queue. This adds time to the printing process. Continuous printing saves time by continuing to print the next job in the queue without stopping (tailgating), if it uses the same print mode and resolution.

---

 **NOTE:** The same print mode and resolution must be used for all jobs in the RIP queue selected for continuous printing, to optimize the overall curing time.

---

 **NOTE:** When continuous printing is enabled, canceling a job could also cancel the subsequent job.

---



## Change margins

The printer margins determine the area between the edges of your image and the edges of the substrate. The 365 or 375 printer with ink collector is capable of printing with no side margins (full bleed).

The side margins for a particular print job are selected in the RIP software; if the job exceeds the substrate width, it will be clipped.

The front panel offers additional settings for the top and bottom margins: see [Margins on page 173](#). These settings apply only to single prints when the cutter is not in use. The top and bottom margins are not applied during double-sided printing.

To set the top margin at the front panel, press , then **Substrate > Substrate handling options > Extra top margin**.

To set the bottom margin at the front panel, press , then **Substrate > Substrate handling options > Extra bottom margin**.

---

 **NOTE:** The extra top/bottom margin set in the front panel is applied in addition to the top/bottom margin selected in the RIP.

 **NOTE:** The side margins can be adjusted in the RIP.

---

## Request the printer's internal prints

The internal prints provide various kinds of information about your printer. Request these prints from the front panel, without using a computer.

Before requesting any internal print, make sure that substrate is loaded and that the **Ready** message appears on the front-panel display.

To print an internal print, press , then **Setup > Internal prints**, then select the type of internal print that you want.

The following internal prints are available:

- Usage report: Shows estimates of the total number of prints, number of prints by substrate family, number of prints by print-quality option, and total amount of ink used per color. The accuracy of these estimates is not guaranteed.
- Service information: Provides information that service engineers require.

## Check lifetime usage statistics

There are two ways of checking your printer's usage statistics.

---

 **NOTE:** The accuracy of the usage statistics is not guaranteed.

---

- From the Embedded Web Server, go to the **Main** tab and select **History > Usage**. See [Embedded Web Server on page 22](#).
- From the front panel, press , then **Setup > Internal prints > User information prints > Print usage report**.

## HP Latex Mobile

Your printer supports a new application called HP Latex Mobile, which marks a new era of smart printers. This app enables you to receive helpful consumables alerts while remotely monitoring your printer and job status on your smartphone or tablet. It also compiles metrics related to ink and substrate usage and productivity that you can view from your tablet. Print with greater confidence, especially as you no longer have to worry about the status of print jobs while you're away from the printer.



 **NOTE:** HP Latex Mobile is compatible with Android 4.1.2 or later and iOS 7 or later, and requires the printer and the smartphone or tablet to be connected to the Internet.

 **NOTE:** Metrics are available on tablets but not on smartphones.

### Rely on alerts to tell you when attention is needed



No more wondering what's going on with your printer while you're away:

- Alerts keep you informed about supplies, the substrate path, and situations when the printer is not ready.
- Return to your printer and take action once you've been alerted.

### Know the status of your printer while you're away from it



HP Latex Mobile offers insight into printer activity and ink and substrate usage:

- Follow printer activity remotely and gain an awareness of your printer at all times.
- Stay abreast of ink levels and the amount of substrate remaining to avoid surprises and respond accordingly.
- Use your tablet to view metrics. Email that information to your computer for more details of ink and substrate usage as well as productivity per printer or job. Use it to improve planning and operations.

## Remotely keep tabs on print jobs

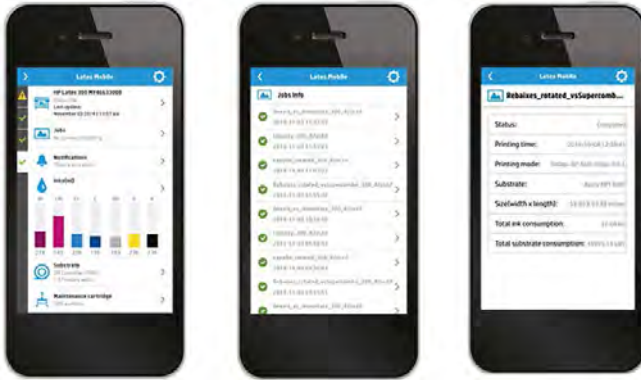

HP Latex Mobile enables you to monitor job completion and job history:

- Track print jobs through to completion.

 **NOTE:** Printer updates occur roughly every five minutes during the printing process and every several hours when the printer is idle. Under certain circumstances, printer updates may be delayed—when system errors occur, for certain substrate jams, in the case of a power outage—in which case the app dashboard display shows the last known printer status.

- Monitor printed jobs through the job history.

## How to add a printer to your mobile device

1. Open the HP Latex Mobile app on your mobile device.
2. Select **Add new HP Latex Printer**.



3. Make a note of the Service ID and Account ID.
4. Go to the printer's front panel and press , then **Setup > Printer Data Sharing Agreement**.
5. Continue until you see the options **Yes, I want to participate, Also send the printer's serial number, and Also send data to printer services**. Select them all.
6. Register a new service and enter the Service ID and Account ID from your mobile device.
7. Press **Continue** and **Accept** until the registration is finished.

Alternatively, you can use the Embedded Web Server instead of the front panel.

1. In the Embedded Web Server, select the **Printer Data Sharing Agreement** tab.
2. Check **Yes, I want to participate (send anonymous data only)**.

3. Check **Also send the printer's serial number**.
4. Check **Also send data to printer services**.
5. Check **Register for a new service**.
6. Enter the Service ID and Account ID from your mobile device and click **Register**.
7. The next screen tells you that the HP Latex to Go service will send status data from the printer to the connected devices through the Internet. Click **Accept**.

## Embedded Web Server



## Introduction to the Embedded Web Server

The Embedded Web Server is a Web server running inside the printer. You can use it to obtain printer information, manage settings and presets, align printheads, upload new firmware and troubleshoot problems. Service engineers can use it to retrieve internal information that helps to diagnose printer problems.

You can access the Embedded Web Server remotely by using an ordinary Web browser running on any computer. See [Access the Embedded Web Server on page 23](#).

The Embedded Web Server window displays three separate tabs. Buttons near the top of each page provide access to online help and supplies reordering.

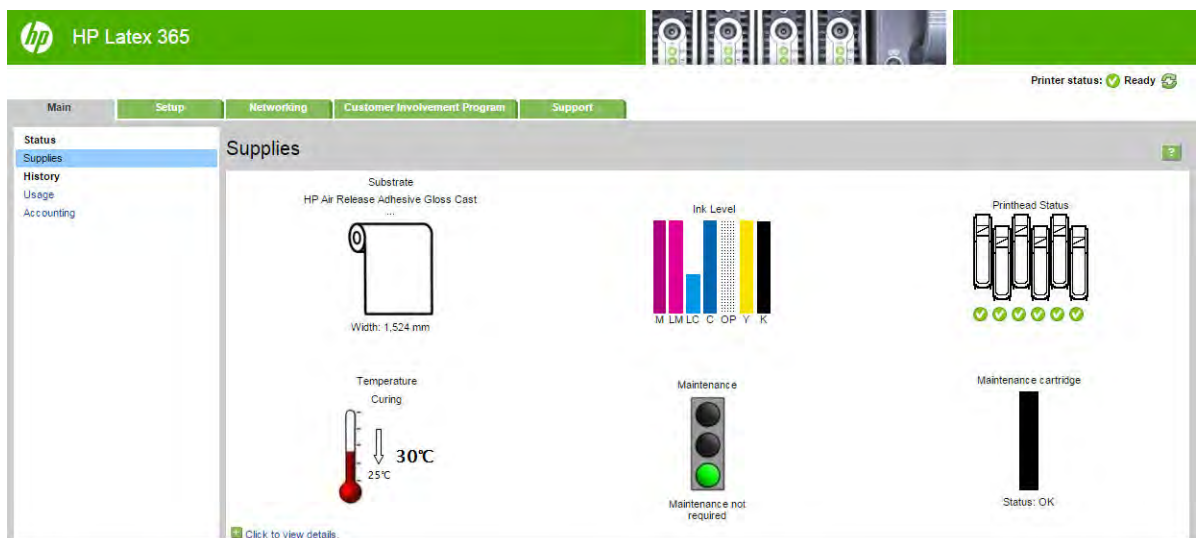

## Main tab

The **Main** tab provides information about the following items.

- Substrate, ink, printhead and maintenance status
- Temperature of the curing module
- Substrate and ink usage and accounting

## Setup tab

The **Setup** tab enables you to complete these tasks.

- Specify printer settings such as units of measurement and refresh date
- Specify network and security settings
- Set the date and time
- Update firmware
- Align printheads
- Upload substrate presets
- Configure e-mail notifications

## Networking tab

The **Networking** tab enables you to change the printer's networking configuration.

## Printer Data Sharing Agreement tab

The **Printer Data Sharing Agreement** tab enables you to sign the Printer Data Sharing Agreement and configure your participation.

## Support tab

The **Support** tab offers various kinds of help with your printer.

- Browse helpful information from a variety of sources
- Troubleshoot problems
- Access HP links for technical support with your printer and accessories
- Access service support pages that show current and historical data on the usage of your printer

## Access the Embedded Web Server

Use the Embedded Web Server to view printer information remotely through an ordinary Web browser running on any computer.

The following browsers are known to be compatible with the Embedded Web Server:

- Internet Explorer 7 and later for Windows
- Safari 3 and later for Mac OS X
- Mozilla Firefox 3.6 and later
- Google Chrome 7 and later

To use the Embedded Web Server on any computer, open your Web browser and type the printer's IP address in the browser's address bar. The printer's IP address appears on the printer's front panel, after pressing the  icon.

If you follow these instructions but fail to open the Embedded Web Server, see [Cannot access the Embedded Web Server on page 163](#).

## Change the language of the Embedded Web Server

The Embedded Web Server functions in the following languages: English, Portuguese, Spanish, Catalan, French, Italian, German, Simplified Chinese, Traditional Chinese, Korean, and Japanese. It uses the language that you specified in your Web browser options. If you specify a language that it cannot support, it functions in English.

To change the language, change your Web browser's language setting. For example, in Chrome, **Settings, Language** (in the advanced settings view), make sure that the language you want is at the top of the list in the dialog box; or, in Internet Explorer version 8, go to the **Tools** menu and select **Internet Options > Languages**. Make sure that the language you want is at the top of the list in the dialog box.

To complete the change, close and reopen your Web browser.

## Restrict access to the printer

From the Embedded Web Server, you can select **Setup > Security** to set an administrator password. Once set, this password must be given in order to perform the following printer functions.

- Clear accounting information.
- Update the printer's firmware.
- Change security settings.
- View protected printer information.
- Change Internet connection settings.
- Change some networking settings.
- Configure the Printer Data Sharing Agreement.
- Run connectivity troubleshooting tests.

For more information, see the Embedded Web Server's online help.

If you forget the administrator password, you can delete the current password from the front panel: press , then **Setup > Connectivity > Advanced > Embedded Web Server > Reset EWS password**.

## Join the Printer Data Sharing Agreement

You can activate or deactivate the Printer Data Sharing Agreement from the Embedded Web Server or from the printer's front panel.



**NOTE:** From the front panel, press , then **Setup > Printer Data Sharing Agreement**.

The Printer Data Sharing Agreement is a statistical printer-usage tracking system. It may also be used to determine eligibility for certain usage-based reward programs, or to monitor the device in connection with optional services such as proactive cartridge replacement, pay-per-use contracts, or support agreements (availability varies by product, region, and country). See the Printer Data Sharing Agreement tab of the Embedded Web Server for details on the data collected and HP's use of the data. Once the Printer Data Sharing

Agreement is enabled, your printer will automatically send 'usage snapshots' to HP through the Internet approximately once a week, for as long as the Printer Data Sharing Agreement remains enabled. The snapshot files are collected on a repository server, then automatically processed to extract the relevant data, which are stored in a usage database. Sending the data does not interfere with the normal operation of your printer, and does not require attention of any kind. You can stop participating at any time, in which case data transmissions stop immediately.

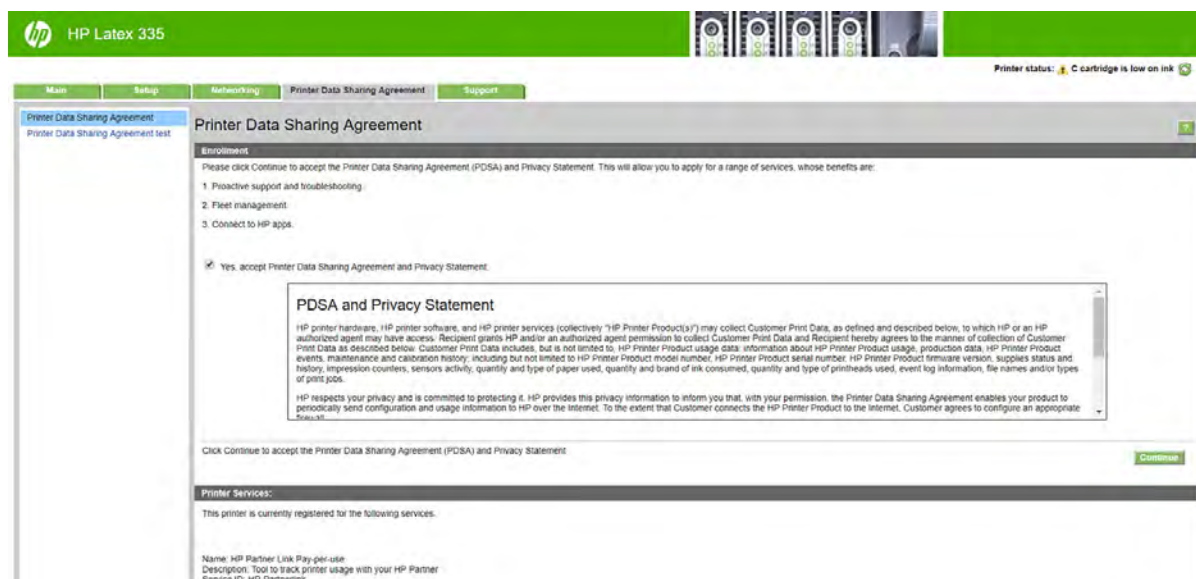

The **PDSA configuration** page of the **Printer Data Sharing Agreement** tab is where you can start, stop, or change your participation in the Printer Data Sharing Agreement. By default, only anonymous usage data are sent to HP, but you have the option to include the printer's serial number. This may be necessary for certain programs or services, and may allow us to provide you with better product service and support. Once you have made any changes to the settings, click the **Apply** button to apply them.

If the Printer Data Sharing Agreement was enabled before clicking the **Apply** button, a connectivity test is automatically made to determine whether Printer Data Sharing Agreement data can be successfully delivered to HP.

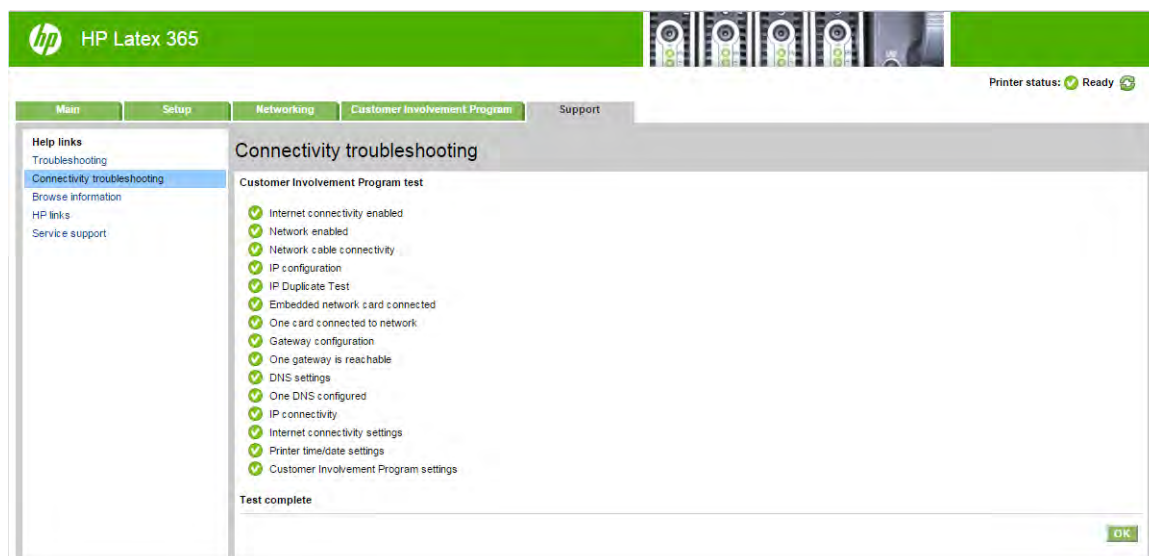

If the test completes successfully, configuration is complete and you can proceed to any other Embedded Web Server page, or close the browser window. If the test fails, follow the instructions to try to identify and fix the problem.

The **PDSA status and test** page of the **Printer Data Sharing Agreement** tab can be used to check the current status (enabled or not, anonymous data or not), and to run a connectivity test to check that Printer Data Sharing Agreement data can be successfully delivered to HP.

## Check printer status

The front panel and the Embedded Web Server both display the status of the printer, the loaded substrate, and the ink system.

## Check the status of the ink system

1. Access the Embedded Web Server (see [Access the Embedded Web Server on page 23](#)).
2. Go to the Supplies page on the **Main** tab.

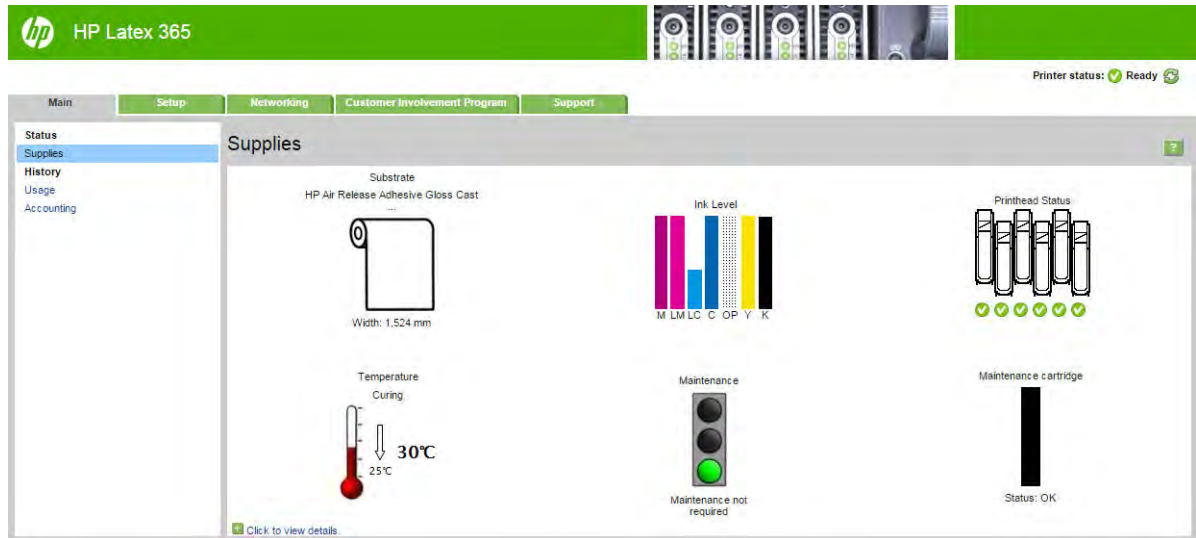

The Supplies page shows you the status of the loaded substrate, the ink cartridges, the printheads, the heater, and the maintenance cartridge.

The traffic light shows whether maintenance is required.

For further information, click **Click to view details**.

## Request email notification of specific error conditions

1. In the Embedded Web Server (see [Access the Embedded Web Server on page 23](#)), go to the Email Server page on the **Setup** tab and ensure that the following fields are correctly filled in:
  - **SMTP server.** This is the IP address of the outgoing mail server (Simple Mail Transfer Protocol [SMTP]) that processes all email messages from the printer. If the mail server requires authentication, email notifications will not work.
  - **Printer email address.** Each email message that the printer sends must include a return address. This address does not need to be a real, functional email address, but it should be unique, so that recipients of the message can identify the printer that sent it
2. Go to the Notification page, which is also on the **Setup** tab.
3. Click the **New** icon to request new notifications, or click the **Edit** icon to edit notifications that have already been set up. Then specify the email addresses to which notifications are sent, and select the incidents that result in notification messages.



## Get accounting information

There are various different ways of getting accounting information from your printer.

- View printer usage statistics for a particular job, see [Check usage statistics for a job on page 27](#).
- View printer usage statistics for the whole lifetime of the printer, see [Check lifetime usage statistics on page 27](#).
- Request accounting data by email. The printer sends data in XML at regular intervals to a specified email address; the data may be interpreted and summarized by a third-party application, or displayed as an Excel spreadsheet. See [Request accounting data by email on page 27](#).
- Use a third-party application to request printer status, printer usage or job accounting data from the printer through the Internet. The printer provides data in XML to the application whenever requested. HP provides a Software Development Kit to facilitate the development of such applications.

By default, user names are not included in accounting information. If you would like to include them, check the box **Show user name in job accounting** in the **Security** menu.

## Check usage statistics for a job

You can use the Embedded Web Server to check usage statistics for a particular job: go to the **Main** tab and select **History > Accounting**.

---

 **NOTE:** The accuracy of the usage statistics is not guaranteed.

---

## Check lifetime usage statistics

There are two ways of checking your printer's usage statistics.

---

 **NOTE:** The accuracy of the usage statistics is not guaranteed.

---

- From the Embedded Web Server, go to the **Main** tab and select **History > Usage**.
- From the front panel, press , then **Setup > Internal prints > User information prints > Print usage report**.

## Request accounting data by email

1. Obtain the IP address of the outgoing mail server (SMTP) from your IT department; this is required in order to send email messages.
2. Ensure that the outgoing email server is configured to enable relaying of email messages that the printer will send.
3. Open your Web browser and connect to the printer's Embedded Web Server.
4. Select the **Setup** tab.
5. From the Configuration menu in the left-hand column, select **Date & Time**.
6. Ensure that the printer's date and time have been set correctly.
7. From the Configuration menu, select **Email server**.
8. Enter the IP address of the outgoing mail server (SMTP).
9. Specify an email address for the printer. The latter does not need to be a valid email address, because the printer will not receive messages; but it should have the form of an email address. It serves to identify the printer when it sends email messages.

10. From the Configuration menu, select **Printer settings**.
11. Set **Send accounting files** to Enabled.
12. Set **Send accounting files to** to the email address (or addresses) to which you want the accounting information sent. This may be an address that you have created specifically to receive automatically generated messages from the printer.
13. Set **Send accounting files every** to the frequency with which you want the information sent, choosing a specific number of days or prints.
14. You may want to set **Exclude personal information from accounting email** to **On**, so that the accounting messages will not contain personal information. If this option is **Off**, information such as user name, job name, and account ID will be included.

When you have completed the above steps, the printer will send accounting data by email with the frequency that you specified. The data are provided in XML and can easily be interpreted by a third-party program. The data provided on each print job include when the job was submitted, when the job was printed, the printing time, the type of image, the number of pages, the number of copies, the paper type and size, the amount of each color of ink used and various other attributes of the job.

You can download an HP DesignJet Accounting Tool from HP's Web site (<http://www.hp.com/go/designjet/accounting/>) that will enable you to display the XML data more readably in the form of a spreadsheet.

Analysis of the accounting data will enable you to bill customers precisely and flexibly for the use of your printer. You can, for instance:

- Bill each customer for the total amount of ink and paper used by that customer over a particular period.
- Bill each customer separately per job.
- Bill each customer separately for each project, broken down by job.

## Connectivity and software instructions

### Connection method

Your printer can be connected in the following way.

Connection type	Speed	Maximum cable length	Other factors
Gigabit Ethernet	Fast; varies according to network traffic	Long (100 m=328 ft)	Requires extra equipment (switches)

 **NOTE:** The speed of any network connection depends on all the components that are used in the network, which can include network interface cards, hubs, routers, switches, and cables. If any one of these components cannot operate at high speed, you will have a low-speed connection. To get the expected performance from your printer, you should use equipment that supports 1000TX Full Gigabit. The speed of your network connection can also be affected by the total amount of traffic from other devices on the network.

### Connect the printer to your network

The printer is able to configure itself automatically for most networks, in a similar way to any computer in the same network. The first time you connect it to a network, this process may take a few minutes. If necessary, see [Advanced network configuration on page 30](#).

Once the printer has a working network configuration, you can check its network address from the front panel:



press .

## Network configuration

For more details about the current network configuration, go to the front panel and press , then

**Connectivity > Network connectivity > Gigabit Ethernet > Modify configuration.** From here it is possible, though not normally necessary, to change the settings manually; this can also be done remotely using the Embedded Web Server.

---

 **TIP:** You may find it helpful to print out the full printer network configuration on paper. This can be done from the front panel: press , then **Internal prints > Service information prints > Print connectivity configuration.** If you do not print out the full network configuration, consider making a note of the printer's IP address and network name.

---

If you accidentally misconfigure the printer's network settings, you can restore the network settings to their factory values from the front panel: press , then **Connectivity > Network connectivity > Advanced > Restore factory settings.** Then you must restart the printer. This automatically provides a working network configuration for most networks. The printer's other settings remain unchanged.

## Using IPv6

Your printer supports almost all network connectivity features using IPv6, just as it does using IPv4. To make full use of IPv6, you may need to connect your printer to an IPv6 network in which there are IPv6 routers and servers.

In most IPv6 networks, the printer will configure itself automatically as follows, and no user configuration is necessary:

1. The printer assigns itself a link-local IPv6 address (which starts with "fe80::").
2. The printer assigns itself stateless IPv6 addresses as indicated to it by any IPv6 routers on the network.
3. If no stateless IPv6 addresses can be assigned, the printer will try to obtain IPv6 addresses using DHCPv6. It will also do so if the routers instruct it to do so.

The stateless and DHCPv6 IPv6 addresses can be used to access the printer, and in most IPv6 networks this will be appropriate.

The link-local IPv6 address works only in the local subnet. Although it is possible to access the printer using this address, it is not recommended.

It is possible to assign a manual IPv6 address to the printer, using the front panel or the Embedded Web Server. It is also possible to disable IPv6 completely in the printer. However, it is not possible to disable IPv4 in the printer, and therefore it is not possible to configure the printer as IPv6-only.

---

 **NOTE:** In typical IPv6 use, your printer will have multiple IPv6 addresses, although it has only one IPv4 address.

 **TIP:** You are recommended to give a name to the printer. You can do this from the front panel or (more easily) from the Embedded Web Server.

**TIP:** You will generally find it easier to use IPv4 unless you have a specific need to use IPv6.

---

Microsoft Windows Vista, Microsoft Windows Server 2008, later versions of Windows, and the new HP Printing and Imaging devices have IPv6 enabled by default. For further information on IPv6, see <http://h20000.www2.hp.com/bc/docs/support/SupportManual/c00840100/c00840100.pdf>. This document discusses how name resolution plays a fundamental role in Dual-Stack transition methods. Using the name resolution algorithm in Windows, the document goes through various network environments and studies how the introduction of routable IPv6 addresses will affect network applications. It also discusses DHCPv6, SLAAC and the impact to DNS, and makes some recommendations.

## Connect the printer to the Internet



To connect to the Internet, go to the front panel and press , then **Connectivity > Connectivity wizard**. The connectivity wizard also checks that the printer's firmware is up to date. Normally you need to run the wizard only once, when first setting up the printer.

An Internet connection is needed for various printer functions described in this guide, such as the Embedded Web Server.

## RIP software installation



Install the RIP software by following the instructions provided with the software.

## Advanced network configuration

You will probably not need to read this section, but the information is provided as it may be useful in some cases.

The printer provides a single RJ-45 connector port for a network connection. In order to meet Class B limits, the use of shielded I/O cables is required.

The embedded Jetdirect print server supports connection to IEEE 802.3 10Base-T Ethernet, IEEE 802.3u 100Base-TX Fast Ethernet and 802.3ab 1000Base-T Gigabit Ethernet compliant networks. When connected and powered on, the printer auto-negotiates with your network to operate with a link speed of 10, 100, or 1000 Mbps, and to communicate using full- or half-duplex mode. However, you can manually configure the link using the printer's front panel, or through other configuration tools once network communication is established.

The printer can support multiple network protocols simultaneously, including TCP/IPv4 and TCP/IPv6. For security, it includes features to control IP traffic to and from the printer.

## Verify correct operation

1. Print an IO Configuration page to check for status messages.
2. In the upper section of the IO Configuration page, look for the status message **I/O Card Ready**.
3. If **I/O Card Ready** appears, the print server is operating properly. Proceed to the next section.

If a message other than **I/O Card Ready** appears, try the following:

- a. Turn the printer off and then on again to re-initialize the print server.
- b. Check that the status indicator lights (LEDs) are providing proper status.



**NOTE:** See [Troubleshooting on page 31](#) for link configuration and troubleshooting information.

See the *HP Jetdirect Print Servers Administrator's Guide* for your print server model to interpret and troubleshoot other messages.

## Preconfigure network settings if required

If your network requires that you configure network settings before you add the printer to your network systems, you can do so now.

However, in most cases, you can skip this section. Instead, you can proceed directly to the next section to install the printer on your network computer systems. The network installation software will allow you to configure basic network settings and add the printer to your system configuration.

## Tools for preconfiguration

The following tools can be used to preconfigure your network settings.

- The front panel
- The Embedded Web Server
- You can use an advanced configuration method, such as BootP, DHCP, Telnet, or the arp and ping commands. For instructions, see the *HP Jetdirect Print Servers Administrator's Guide* for your print server model.

After the printer is configured with network settings, the configuration values are saved and maintained even after it is turned off and on again.

## Troubleshooting

### IO Configuration page

The IO Configuration page provides comprehensive print server status. It is an important diagnostic tool, especially if network communications are not available. For a description of messages that may appear on the IO Configuration page, see the *HP Jetdirect Print Servers Administrator's Guide* for your print server model.

### LEDs

The printer has status lights (LEDs) that indicate the link status and network activity.

- When the green light is on, the printer has successfully linked to the network.
- When the yellow light is blinking, there is network transmission activity.

### Link troubleshooting

If the printer does not successfully connect to the network:

- Both LEDs will be off.
- **LAN Error - Loss of Carrier** will be indicated on the IO Configuration page.

If a link failure is indicated, try the following:

- Check cable connections.
- Print an IO Configuration page and check link settings.

Item	Description
Port Config	<p>If the printer is properly linked, this item has one of the following values:</p> <ul style="list-style-type: none"> <li>– <b>10BASE-T HALF:</b> 10 Mbps, half-duplex</li> <li>– <b>10BASE-T FULL:</b> 10 Mbps, full-duplex</li> <li>– <b>100TX-HALF:</b> 100 Mbps, half-duplex</li> <li>– <b>100TX-FULL:</b> 100 Mbps, full-duplex</li> <li>– <b>1000TX FULL</b></li> </ul> <p>If the printer is not properly linked, one of the following messages will appear:</p> <ul style="list-style-type: none"> <li>– <b>UNKNOWN:</b> The printer is in an initialization state.</li> <li>– <b>DISCONNECTED:</b> A network connection has not been detected. Check network cables. Reconfigure the link settings, or restart the printer.</li> </ul>
Auto Negotiation	<p>Indicates whether auto-negotiation for link configuration is on or off.</p> <ul style="list-style-type: none"> <li>– <b>ON (default):</b> The printer will attempt to automatically configure itself onto the network at the proper speed and communication mode.</li> <li>– <b>OFF:</b> You must manually configure the link speed and communication mode using the front panel. Your settings must match those of the network for proper operation.</li> </ul>

## Reset network parameters

Network parameters (for example, the IP address) can be reset to factory default values by a cold reset: turning the printer off and on again. After a cold reset, print an IO Configuration page to confirm that factory-reset values have been assigned.

**CAUTION:** A factory-installed HP Jetdirect X.509 certificate will be saved over a cold reset to factory default values. However, a Certificate Authority (CA) certificate that has been installed by the user to validate a network authentication server will not be saved.

## Menu items

Menu item	Sub-menu item	Sub-menu item	Values and Description
TCP/IP	Host Name		An alphanumeric string, up to 32 characters, used to identify the device. This name is listed on the HP Jetdirect configuration page. The default host name is NPLxxxxxx, where xxxxxx is the last six digits of the LAN hardware (MAC) address.
	IPv4 Settings	Config Method	<p>Specifies the method that TCP/IPv4 parameters will be configured on the HP Jetdirect print server.</p> <p><b>Bootp:</b> Use BootP (Bootstrap Protocol) for automatic configuration from a BootP server.</p> <p><b>DHCP (default):</b> Use DHCP (Dynamic Host Configuration Protocol) for automatic configuration from a DHCPv4 server. If selected and a DHCP lease exists, <a href="#">DHCP Release</a> and <a href="#">DHCP Renew</a> menus are available to set DHCP lease options.</p> <p><b>Auto IP:</b> Use automatic link-local IPv4 addressing. An address in the form 169.254.x.x is assigned automatically.</p> <p><b>Manual:</b> Use the <a href="#">Manual Settings</a> menu to configure TCP/IPv4 parameters.</p>

Menu item	Sub-menu item	Sub-menu item	Values and Description
		DHCP Release	<p>This menu appears if <a href="#">Config Method</a> was set to <a href="#">DHCP</a> and a DHCP lease for the print server exists.</p> <p><b>No</b> (default): The current DHCP lease is saved.</p> <p><b>Yes</b>: The current DHCP lease and the leased IP address are released.</p>
		DHCP Renew	<p>This menu appears if <a href="#">Config Method</a> was set to <a href="#">DHCP</a> and a DHCP lease for the print server exists.</p> <p><b>No</b> (default): The print server does not request to renew the DHCP lease.</p> <p><b>Yes</b>: The print server requests to renew the current DHCP lease.</p>
		Manual Settings	<p>(Available only if <a href="#">Config Method</a> is set to <a href="#">Manual</a>) Configure parameters directly from the printer control panel:</p> <p><b>IP Address</b>: The unique IP address of the printer (n.n.n.n).</p> <p><b>Subnet Mask</b>: The subnet mask for the printer (n.n.n.n).</p> <p><b>Syslog Server</b>: The IP address of the syslog server (n.n.n.n) used to receive and log syslog messages.</p> <p><b>Default Gateway</b>: The IP address (n.n.n.n) of the gateway or router used for communications with other networks.</p> <p><b>Idle Timeout</b>: The time period, in seconds, after which an idle TCP print data connection is closed (default is 270 seconds, 0 disables the timeout).</p>
		Default IP	<p>Specify the IP address to default to when the print server is unable to obtain an IP address from the network during a forced TCP/IP reconfiguration (for example, when manually configured to use BootP or DHCP).</p> <p><b>Auto IP</b>: A link-local IP address 169.254.x.x is set.</p> <p><b>Legacy</b>: The address 192.0.0.192 is set, consistent with older HP Jetdirect devices.</p>
		Primary DNS	<p>Specify the IP address (n.n.n.n) of a Primary DNS Server.</p> <p><b>NOTE</b>: This item appears only if <a href="#">Manual</a> configuration is a higher priority than <a href="#">DHCP</a> in the <b>Config. Precedence</b> table, configured through the embedded Web server.</p>
		Secondary DNS	<p>Specify the IP address (n.n.n.n) of a Secondary Domain Name System (DNS) Server.</p> <p><b>NOTE</b>: This item will appear only if <a href="#">Manual</a> configuration is a higher priority than <a href="#">DHCP</a> in the <b>Config. Precedence</b> table, configured through the embedded Web server.</p>
	IPv6 Settings	Enable	<p>Use this item to enable or disable IPv6 operation on the print server.</p> <p><b>Off</b>: IPv6 is disabled.</p> <p><b>On (default)</b>: IPv6 is enabled.</p>

Menu item	Sub-menu item	Sub-menu item	Values and Description
		Address	<p>Use this item to manually configure an IPv6 address.</p> <p><b>Manual Settings:</b> Use the <a href="#">Manual Settings</a> menu to enable and manually configure a TCP/ IPv6 address.</p> <p><b>Enable:</b> Select this item and choose <b>On</b> to enable manual configuration, or <b>Off</b> to disable manual configuration.</p> <p><b>Address:</b> Use this item to type a 32 hexadecimal digit IPv6 node address that uses the colon hexadecimal syntax.</p>
		DHCPv6 Policy	<p><b>Router Specified:</b> The stateful auto-configuration method to be used by the print server is determined by a router. The router specifies whether the print server obtains its address, its configuration information, or both from a DHCPv6 server.</p> <p><b>Router Unavailable:</b> If a router is not available, the print server should attempt to obtain its stateful configuration from a DHCPv6 server.</p> <p><b>Always:</b> Whether or not a router is available, the print server always attempts to obtain its stateful configuration from a DHCPv6 server.</p>
		Primary DNS	<p>Use this item to specify an IPv6 address for a primary DNS server that the print server should use.</p> <p><b>NOTE:</b> This item will appear only if <b>Manual</b> configuration is a higher priority than <b>DHCP</b> in the <b>Config Precedence</b> table, configured through the embedded Web server.</p>
		Secondary DNS	<p>Use this item to specify an IPv6 address for a secondary DNS server that the print server should use.</p> <p><b>NOTE:</b> This item will appear only if <b>Manual</b> configuration is a higher priority than <b>DHCP</b> in the <b>Config Precedence</b> table, configured through the embedded Web server.</p>
	Proxy Server		<p>Specifies the proxy server to be used by embedded applications in the device. A proxy server is typically used by network clients for Internet access. It caches Web pages, and provides a degree of Internet security, for those clients.</p> <p>To specify a proxy server, enter its IPv4 address or fully-qualified domain name. The name can be up to 255 octets.</p> <p>For some networks, you may need to contact your Independent Service Provider (ISP) for the proxy server address.</p>
		Proxy Port	<p>Type the port number used by the proxy server for client support. The port number identifies the port reserved for proxy activity on your network, and can be a value from 0 to 65535.</p>
Information	Print Sec Page		<p><b>Yes:</b> Prints a page that contains the current security settings on the HP Jetdirect print server.</p> <p><b>No (default):</b> A security settings page is not printed.</p>



Menu item	Sub-menu item	Sub-menu item	Values and Description
Security	Secure Web		<p>For configuration management, specify whether the embedded Web server will accept communications using HTTPS (Secure HTTP) only, or both HTTP and HTTPS.</p> <p><b>HTTPS Required:</b> For secure, encrypted communications, only HTTPS access is accepted. The print server will appear as a secure site.</p> <p><b>HTTP/HTTPS optional:</b> Access using either HTTP or HTTPS is permitted.</p> <p><b>NOTE:</b> The factory default setting depends on the print server model.</p>
	Reset Security		<p>Specify whether the current security settings on the print server will be saved or reset to factory defaults.</p> <p><b>No</b> (default): The current security settings are maintained.</p> <p><b>Yes:</b> Security settings are reset to factory defaults.</p>
Link Speed			<p>The link speed and communication mode of the print server must match the network. The available settings depend on the device and installed print server. Select one of the following link configuration settings:</p> <p><b>CAUTION:</b> If you change the link setting, network communications with the print server and network device might be lost.</p> <p><b>Auto</b> (default): The print server uses auto-negotiation to configure itself with the highest link speed and communication mode allowed. If auto-negotiation fails, either 100TX HALF or 10TX HALF is set depending on the detected link speed of the hub/switch port. (A 1000T half-duplex selection is not supported.)</p> <p><b>10T Half:</b> 10 Mbps, half-duplex operation.</p> <p><b>10T Full:</b> 10 Mbps, Full-duplex operation.</p> <p><b>100TX Half:</b> 100 Mbps, half-duplex operation.</p> <p><b>100TX Full:</b> 100 Mbps, full-duplex operation.</p> <p><b>100TX Auto:</b> Limits auto-negotiation to a maximum link speed of 100 Mbps.</p> <p><b>1000TX Full:</b> 1000 Mbps, full-duplex operation.</p>

## Embedded services

Key networking services embedded in the printer are listed below. For the latest features and services, visit <http://www.hp.com/go/jetdirect>.

- Configuration and Management
  - BootP/DHCP (IPv4 only)
  - DHCPv6
  - TFTP (IPv4 only)
  - Web Proxy (Automatic/Manual cURL)
  - LLNMR

- Telnet (IPv4 only)
- SNMP (v1, v2c, v3) agents
- Bonjour (for Mac OS X)
- FTP (File Transfer Protocol)
- Embedded Web Server, HTTP (TCP port 80)
- Embedded Web Server, HTTPS (TCP port 443)
- Printing
  - Raw IP printing (HP-proprietary TCP ports 9100, 9101, 9102)
- Security
  - SNMP v3
  - SSL/TLS
  - Firewall

## Turn the printer on and off

To turn on the printer, ensure that the power switch at the rear of the printer is turned on, then press the power button beside the front panel.

You can leave the printer on without wasting energy. Leaving it on improves response time. When the printer has not been used for a certain period of time, it saves power by going into sleep mode. Pressing the power button returns it to active mode, and it can resume printing immediately.

To turn off the printer, the normal and recommended method is to press the power button.



When you turn off the printer this way, the printheads are automatically stored with the maintenance cartridge, which prevents them from drying out.

However, if you plan to leave the printer turned off for a long period of time, you are recommended to turn it off using the power button, and then also turn off the power switch at the rear.

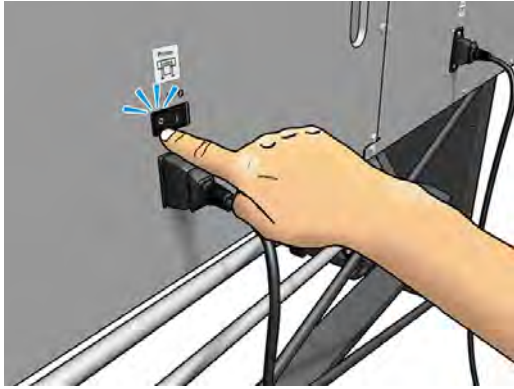

To turn it back on later, use the power switch at the rear. If the printer does not start automatically, press the power button.

When the printer is turned on, it takes 2–3 minutes to initialize itself.

## Restart the printer

In some circumstances you may be advised to restart the printer.

1. Turn off the printer by pressing the power button and then turning off the power switch at the rear of the printer.
2. Wait for at least 10 seconds.
3. Turn on the power switch at the rear of the printer.
4. If the front panel does not activate, press the power button.

---

## 2 Useful links

Visit the HP Latex Knowledge Center at <http://www.hp.com/communities/HPLatex>, where you can find detailed information about our HP Latex products and applications, and use the forum to discuss anything related to the business.

Product documentation: <http://www.hp.com/go/latex300/manuals/>

User training (quick guide) is already installed in your computer. To reinstall: <http://www.hp.com/go/latex300/quickguide/>

Videos about how to use the printer: <http://www.hp.com/supportvideos/> or <http://www.youtube.com/HPSupportAdvanced>

Information about software RIPs, applications, solutions, inks, and substrates: <http://www.hp.com/go/latex300/solutions/>

Substrate presets: <http://www.hp.com/go/mediasolutionslocator> (see [HP Media Locator on page 91](#))

HP Support: <http://www.hp.com/go/latex300/support/>

Embedded Web Server: Use the printer's IP address (see [Access the Embedded Web Server on page 23](#))

Registration and communication with HP: <http://www.hp.com/communities/HPLatex/>.

## When you need help

In most countries, support is provided by HP support partners (usually the company that sold you the printer). If this is not the case in your country, contact HP Support on the Web as shown above.

Help is also available to you by telephone. What to do before you call:

- Review the troubleshooting suggestions in this guide.
- Review your RIP's documentation, if relevant.
- Please have the following information available:
  - The printer you are using: the product number, the serial number and the service ID



**NOTE:** This information is available from the front panel: press . You may also find it on a label at the rear of the printer.

---

- If there is an error code on the front panel, note it down; see [Front-panel error codes on page 166](#)
- The RIP you are using, and its version number
- If you have a print-quality problem: the substrate reference, and the name and origin of the substrate preset used to print on it.
- The service information report (see [Service information on page 39](#))

## Telephone number

Your HP Support telephone number is available on the Web: please visit [http://welcome.hp.com/country/us/en/wwcontact\\_us.html](http://welcome.hp.com/country/us/en/wwcontact_us.html).

## Customer Self Repair

HP's Customer Self Repair program offers our customers the fastest service under either warranty or contract. It enables HP to ship replacement parts directly to you (the end user) so that you can replace them. Using this program, you can replace parts at your own convenience.

### Convenient, easy to use

- An HP Support Specialist will diagnose and assess whether a replacement part is required to address a defective hardware component.
- Replacement parts are express-shipped; most in-stock parts are shipped the very same day you contact HP.
- Available for most HP products currently under warranty or contract.
- Available in most countries.

For more information about Customer Self Repair, see <http://www.hp.com/go/selfrepair/>.

## Service information

The printer can produce on request a list of many aspects of its current status, some of which may be useful to a service engineer trying to fix a problem. There are two different ways to request this list:

- In the Embedded Web Server (see [Access the Embedded Web Server on page 23](#)), select the **Support** tab and then **Service support > Printer information**. You are recommended to request the whole list (select **All pages**).
- From any computer with Internet access, enter the URL of your printer into a Web browser, followed by `/hp/device/webAccess/allServicePlot.htm`. For instance, if the URL of your printer is **http://123.123.123.123**, enter:

`http://123.123.123.123/hp/device/webAccess/allServicePlot.htm`

If you need to send the list by email, you can save the page as a file from your Web browser, and later send the file. Alternatively, from Internet Explorer you can send the page directly: select **File > Send > Page by email**.

---

## 3 Handle the substrate and troubleshoot substrate issues

- [Overview](#)
- [Porous substrates](#)
- [Load a roll onto the spindle](#)
- [Load a roll into the printer](#)
- [Ink collector \(365 and 375 only\)](#)
- [Loading accessory \(365 and 375 only\)](#)
- [Assisted manual load](#)
- [Edge holders](#)
- [Load a cut sheet into the printer](#)
- [Unload a roll from the printer](#)
- [Take-up reel](#)
- [Double-sided printing \(365 and 375 only\)](#)
- [View information about the substrate](#)
- [Change substrate width and right edge position](#)
- [Substrate length tracking](#)
- [Cut substrate](#)
- [Bypass job start safety](#)
- [Store the substrate](#)
- [Substrate cannot be loaded successfully](#)
- [Substrate is mispositioned](#)
- [Substrate has jammed](#)
- [Substrate is deformed or wrinkled](#)
- [Substrate has shrunk or expanded](#)
- [Substrate has bow deformation](#)
- [Substrate is sticky and causes smears and crashes](#)

- [Automatic cutter does not work](#)
- [Take-up reel substrate jam](#)
- [Take-up reel does not wind](#)

# Overview

You can print on a wide variety of printing materials, all of which are referred to in this guide as substrates.

## Substrate tips

Choosing the correct substrate for your needs is an essential step in ensuring good print quality.

Here are some tips about substrate usage.

- To print on textile substrates, in most cases you should use the ink collector. See [Ink collector \(365 and 375 only\) on page 55](#).
- Using the take-up reel with some substrates, such as textiles, may give the printer better control of the substrate and is likely to improve print quality. See [Take-up reel on page 69](#).
- Allow all substrates to adapt to room conditions, out of the packaging, for 24 hours before using them for printing.
- Handle film and photo substrates by the edges, or wear cotton gloves. Skin oils can be transferred to the substrate, leaving fingerprint marks.
- Keep the substrate tightly wound on the roll throughout the loading and unloading procedures. To make sure that the roll stays tightly wound, consider using tape to stick the leading edge of the roll to the core just before removing the roll from the printer. You can keep the roll taped during storage. If the roll starts to unwind, it can become difficult to handle.



**NOTE:** The use of tape to stick the leading edge of the roll to the core is especially important for heavy substrates, because the inherent stiffness of the substrate can cause it to loosen and unwind from the core.

- Print quality could be impaired if you use a substrate that is unsuitable for your image.
- Make sure that the appropriate print-quality setting is selected in the RIP.
- Whenever you load a roll, the front panel prompts you to specify the substrate type that you are loading. For good print quality, it is essential to specify this correctly. Check that the substrate name is the same in the front panel and in the RIP.

If the names are not the same, press  on the front panel, then **Substrate > Change loaded substrate;** or change the substrate in the RIP.

- Do not pull the printed substrate while the printer is printing: this can cause severe print-quality defects.





- When printing a series of jobs, do not let the printed substrate obstruct the output path: this can cause severe print-quality defects.



- For more substrate tips, see [Load a roll into the printer on page 52](#) and [Assisted manual load on page 63](#).

**CAUTION:** Removing the substrate from the printer manually without using the front panel could damage the printer. Do this only when necessary to clear a substrate jam.









## Supported substrate categories



Substrate category	Substrate types	Generic substrate names
Self-Adhesive Vinyl	Cast self-adhesive vinyl	Generic Self-Adhesive Vinyl
	Calendered self-adhesive vinyl	Generic Self-Adhesive Vinyl High Ink
	Perforated self-adhesive vinyl	
	Transparent self-adhesive vinyl	
	Reflective self-adhesive vinyl	
Textile	Polyester textile and fabric	Generic Textile
	Textile banner	Generic Canvas & Coated Textiles
	Backdrops	
	Textile mesh with liner	
	Frontlit textile, with liner if porous	
	Backlit textile, with liner if porous	
	Canvas	
	Flag and voile with liner	
	Cotton textile	
	Self-adhesive textile	

Substrate category	Substrate types	Generic substrate names
PVC Banner	Frontlit banner	Generic PVC Banner
	Backlit banner	Generic Backlit PVC Banner
	Scrim banner	
	Scrimless banner	
	Mesh banner with liner	
	Blockout banner	
	Truck curtain banner or tarpaulin	
PP and PE Film and Banner	Polypropylene (PP) film	Generic PP & PE Synthetics
	Synthetic paper (such as Yupo)	
	Tyvek	
	Coated PE/HDPE (polyethylene) banner	
PET Film	Polyester (PET) backlit film	Generic Polyester Film
	Polyester (PET) frontlit film	Generic Backlit Polyester Film
	Polyester (PET) grey-back film	
Paper	Coated paper	Generic Paper
	Uncoated paper	Generic Coated Paper
	Photo paper	Generic Backlit Paper
	Blue-back paper	
	Self-adhesive paper	

## Supported HP substrates

Category	Substrate	Color calib.	Applications
Self-Adhesive Vinyl	HP Air Release Adhesive Gloss Cast Vinyl	Yes	Vehicle wraps, car/bus/track fleets, signs
	Without liner: 50 microns (2 mil) • 100 g/m <sup>2</sup> • 45.7 m (150 ft)		
	With liner: 241 microns (9.5 mil) • 260 g/m <sup>2</sup> • 45.7 m (150 ft)		
	HP Permanent Gloss Adhesive Vinyl	Yes	
	Without liner: 88 microns (3.5 mil) • 145 g/m <sup>2</sup> • 45.7 m (150 ft)/ 91,4 m (300 ft)		
	With liner: 238 microns (9.4 mil) • 270 g/m <sup>2</sup> • 45.7 m (150 ft)/ 91,4 m (300 ft)		
	HP Permanent Matte Adhesive Vinyl	Yes	
	Without liner: 88 microns (3.5 mil) • 145 g/m <sup>2</sup> • 45.7 m (150 ft)/ 91,4 m (300 ft)		
	With liner: 238 microns (9.4 mil) • 270 g/m <sup>2</sup> • 45.7 m (150 ft)/ 91,4 m (300 ft)		
HP One-View Perforated Adhesive Window Vinyl	HP One-View Perforated Adhesive Window Vinyl	No	
	Without liner: 165 microns (6.5 mil) • 155 g/m <sup>2</sup> • 50 m (164 ft)		
	With liner: 406 microns (16 mil) • 288 g/m <sup>2</sup> • 50 m (164 ft)		

Category	Substrate	Color calib.	Applications	
Textile	New HP Light Textile Display Banner 	No	Indoor flags, wall murals, interior decoration, fine arts	
	See <a href="http://www.globalbmg.com/hp/">http://www.globalbmg.com/hp/</a>			
	HP Heavy Textile Banner 			
	See <a href="http://www.globalbmg.com/hp/">http://www.globalbmg.com/hp/</a>			
	HP Satin Canvas	Yes		
	419 microns (16.5 mil) • 375 g/m <sup>2</sup> • 14.9 m (49 ft)			
	New HP Premium Satin Canvas			
	463 microns (18.2 mil) • 381 g/m <sup>2</sup> • 22.9 m (75 ft)			
Textile	New HP Everyday Satin Canvas			
	444 microns (17.5 mil) • 340 g/m <sup>2</sup> • 22.9 m (75 ft)			
	New HP PVC-free Durable Suede Wall Paper			
	See <a href="http://www.globalbmg.com/hp/">http://www.globalbmg.com/hp/</a>			
	PVC Banner	HP Durable Frontlit Scrim Banner	Yes	Banners, POP, flags, track covers, wall murals
		449 microns (17.7 mil) • 535 g/m <sup>2</sup> • 35 m (115 ft)		
	PP and PE Film and Banners	New HP HDPE Reinforced Banner 	Yes	Banners, POP, flags, track covers, wall murals, large photographs, floor covering
		203 microns (8 mil) • 170 g/m <sup>2</sup> • 45.7 m (150 ft)		
HP Double-sided HDPE Reinforced Banner				
See <a href="http://www.globalbmg.com/hp/">http://www.globalbmg.com/hp/</a>				
New HP Everyday Matte Polypropylene, 3 in core 		Yes		
203 microns (8 mil) • 120 g/m <sup>2</sup> • 61 m (200 ft)				
PP and PE Film and Banners	New HP Everyday Adhesive Matte Polypropylene, 3 in core	Yes		
	Without liner: 180 microns (7.1 mil) • 120 g/m <sup>2</sup> • 30.5 m (100 ft)			
	With liner: 215 microns (8.5 mil) • 168 g/m <sup>2</sup> • 30.5 m (100 ft)			
	HP DuPont Tyvek Banner 	No		
PET Film	New HP Backlit Polyester Film 	No	Bus shelters, airport ads, POP, street ads	
	220 microns (8.7 mil) • 285 g/m <sup>2</sup> • 30.5 m (100 ft)			
Paper	HP PVC-Free Wall Paper	Yes	POP indoor and outdoor, windows, bus shelters, billboards, wall decorations	
	177 microns (7 mil) • 175 g/m <sup>2</sup> • 30.5 m (100 ft)			
	HP White Satin Poster Paper 			
	165 microns (6.5 mil) • 136 g/m <sup>2</sup> • 61 m (200 ft)			
	HP Blue Back Billboard Paper	Yes		
	165 microns (6.5 mil) • 123 g/m <sup>2</sup> • 80 m (262 ft)			
Paper	New HP Universal Coated Paper, 3 in core 	Yes		
	124 microns (4.9 mil) • 90 g/m <sup>2</sup> • 61 m (200 ft)			

Category	Substrate	Color calib.	Applications
	New HP Coated Paper, 3 in core 	Yes	
	114 microns (4.5 mil) • 90 g/m <sup>2</sup> • 61 m (200 ft)		
	New HP Universal Heavyweight Coated Paper, 3 in core 	Yes	
	165 microns (6.5 mil) • 125 g/m <sup>2</sup> • 61 m (200 ft)		
	New HP Heavyweight Coated Paper, 3 in core 	Yes	
	167 microns (6.6 mil) • 130 g/m <sup>2</sup> • 61 m (200 ft)		
	New HP Super Heavyweight Plus Matte Paper, 3 in core 	Yes	
	259 microns (10.2 mil) • 210 g/m <sup>2</sup> • 61 m (200 ft)		
	New HP Professional Gloss Photo Paper		
	See <a href="http://www.globalbmg.com/hp/">http://www.globalbmg.com/hp/</a>		
	New HP Professional Satin Photo		
	See <a href="http://www.globalbmg.com/hp/">http://www.globalbmg.com/hp/</a>		
	New HP Everyday Satin Photo Paper		
	See <a href="http://www.globalbmg.com/hp/">http://www.globalbmg.com/hp/</a>		

- For third-party substrate solutions with ColorPRO technology, please visit <http://ColorPROtechnology.com/>.
- HP PVC-free Wall Paper printed with HP Latex Inks is rated A+ according to *Émissions dans l'air intérieur*, which provides a statement of the level of emission of volatile substances in indoor air posing health risks if inhaled—on a scale from A+ (very low emission) to C (high emission).
- HP PVC-Free Wall Paper printed with HP Latex Inks is GREENGUARD Children & Schools Certified. See <http://www.greenguard.org/>.
- HP PVC-Free Wall Paper printed with HP Latex Inks meets AgBB criteria for health-related evaluation of VOC emissions of indoor building products. See <http://www.umweltbundesamt.de/produkte-e/bauprodukte/agbb.htm>.

 HP large-format substrate take-back program availability varies. Some recyclable HP substrates can be recycled through commonly available recycling programs. Recycling programs may not exist in your area. See <http://www.hp.com/recycle/> for details.

## Porous substrates

Porous substrates may be used with the 365 or 375 printer and the ink collector, with which you must use the take-up reel.

The 315 and 335 printers are not designed to be used with porous substrates, and could be damaged by them, requiring a service repair not covered by your warranty.

To check the porosity of your substrate, proceed as follows.

1. If the printer has any substrate loaded, unload it.
2. Cut a piece of self-adhesive vinyl white gloss 15 × 50 mm (0.6 × 2 in) in size.

3. Stick it to the platen as shown.



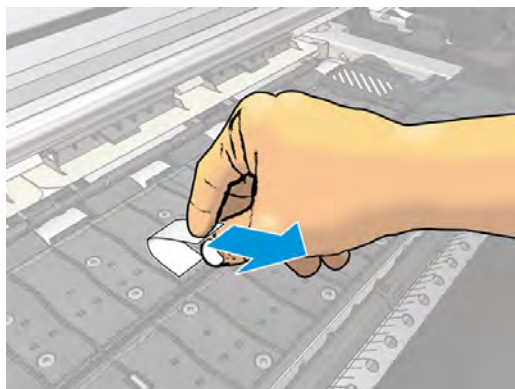

4. Load the substrate that you want to check.
5. Open your RIP software.
6. Download the test file from inside the printer: [http://printerIP/hp/device/webAccess/images/Ink\\_trespassing\\_check.pdf](http://printerIP/hp/device/webAccess/images/Ink_trespassing_check.pdf), where *printerIP* is the IP address of your printer.
7. Print the test file using the number of passes and substrate preset that you intend to use in future with this substrate (or a similar profile in terms of ink limit).
8. Unload the substrate.
9. Remove the strip of self-adhesive vinyl from the platen.



10. Look at the self-adhesive vinyl you have taken from the platen.
  - If the strip is completely white (has no ink on it), the tested substrate is non-porous and can be used for printing as described in this guide.
  - If there some ink on the strip, the tested substrate is porous and should not be used with the 315 or 335 printers. It may be used with the 365 or 375 printer and the ink collector.
11. Clean the platen: see [Clean the platen on page 153](#).

## Load a roll onto the spindle

 **TIP:** As an alternative to the description here, you can see an animation of this procedure in the front panel: press , then **Substrate > Substrate load > Learn how to load spindle**.

1. Make sure that the printer wheels are locked (the brake lever is pressed down) to prevent the printer from moving.

2. Lift the spindle lock lever to disengage the spindle.

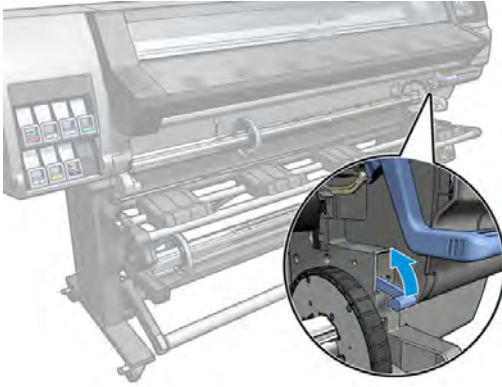

3. Remove the spindle from the printer.

**⚠ CAUTION:** Do not insert your fingers into the spindle supports.

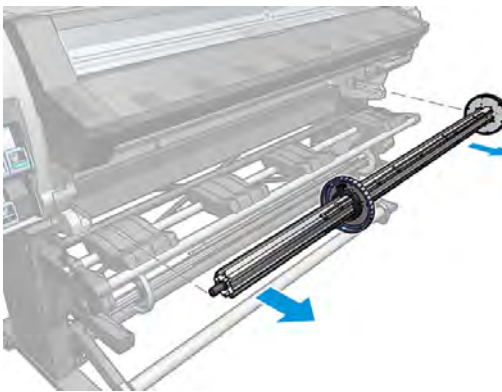

The spindle has a stop at each end to keep the roll in position. Remove the blue stop at the left end to mount a new roll (the stop at the other end of a 76 mm (3 in) diameter spindle can also be removed, if you wish). The stop slides along the spindle to hold rolls of different widths.

4. Unlock the blue stop.

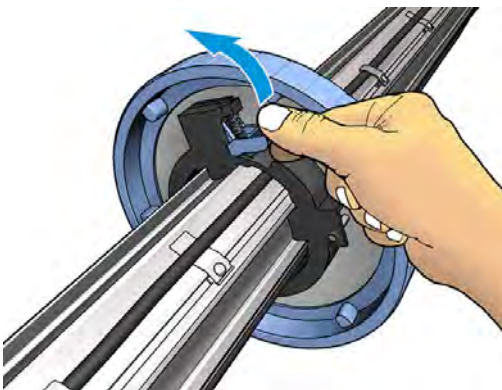

5. Remove the stop from the left end of the spindle.

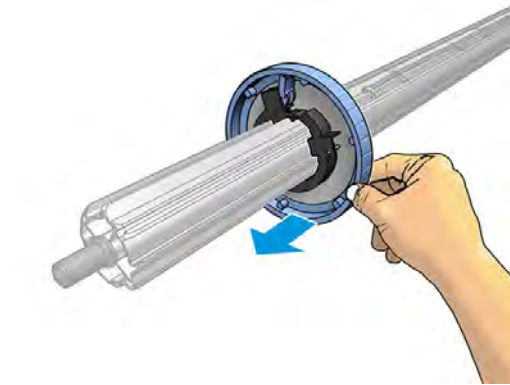

6. Place the roll onto the loading table.

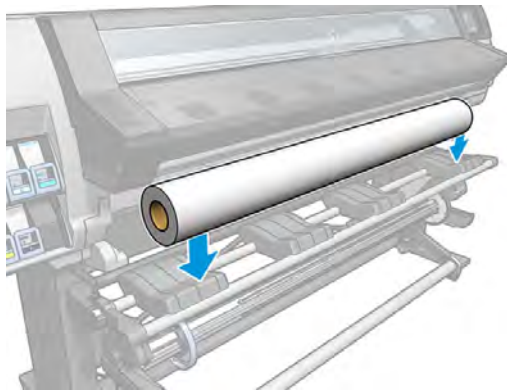

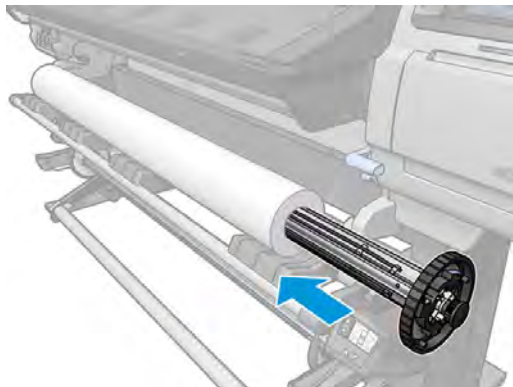

7. Slide the spindle into the roll.



8. The right stop of the 76 mm (3 in) diameter spindle has two positions: one for rolls of the printer's maximum width, and another for narrower rolls. Remember to use the second position for narrower rolls, which improves the curing process and allows higher printing speeds.



 **NOTE:** The 76 mm (3 in) diameter spindle is supplied with the 365 and 375 printers and is available as an accessory for the 335 printer.

 **NOTE:** The 51 mm (2 in) diameter spindle supplied with the 315 and 335 printers has only one position for the right stop. There are blue lines on the loading table corresponding to two positions, but when using this spindle you can use only the outer position.

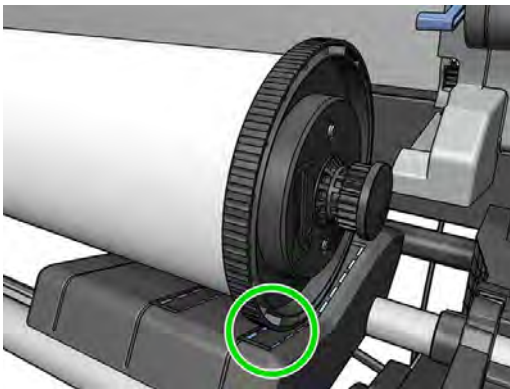

9. Put the blue stop on to the upper end of the spindle, and push it towards the end of the roll.

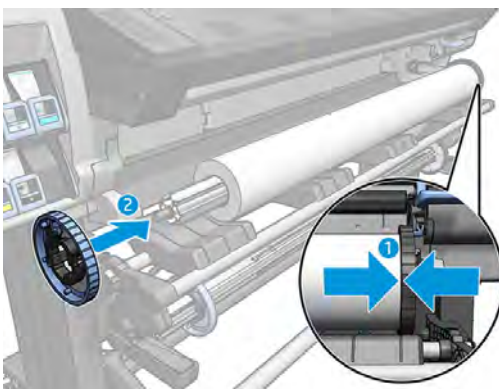



10. Lock the blue stop when it is in contact with the substrate.

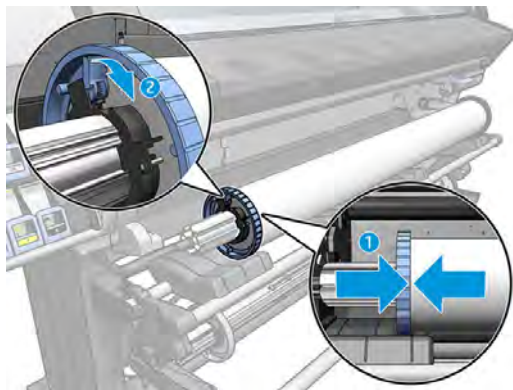

11. Insert the spindle carefully into the printer.

**⚠ WARNING!** Avoid trapping your fingers between the spindle and the spindle supports.



Risk of trapped fingers

For more safety information, please see [Safety precautions on page 3](#)

**⚠ CAUTION:** Ensure that the sliders in the loading table are under the left hub, otherwise the spindle will not enter correctly into the left spindle support, and could fall on the floor.

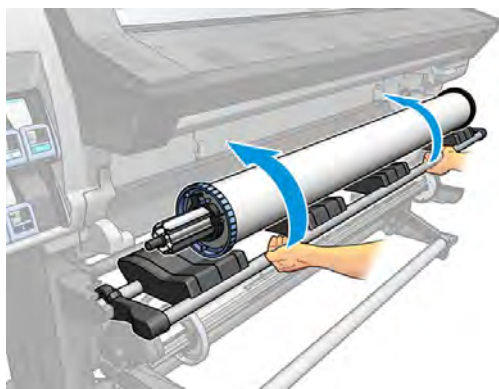

If you regularly use different substrates, you can change rolls more quickly if you pre-load rolls of different substrates on different spindles. Extra spindles are available for purchase.

## Load a roll into the printer



To start this procedure, you need to have a roll loaded on the spindle. See [Load a roll onto the spindle on page 47](#).

The normal minimum substrate width is 23 inches (584 mm). To load substrates down to a minimum width of 10 inches (254 mm), go to the front panel and press , then **Substrate > Substrate handling options > Enable narrow substrate**. With this option, print quality is not guaranteed.

 **TIP:** To load a roll of textile substrate, see [Loading accessory \(365 and 375 only\) on page 59](#); and remember to use the ink collector if the substrate is porous (which textiles usually are).

**TIP:** When loading very thin or very thick substrates, or substrates with a tendency to curl, you should follow the manual loading procedure to reduce the risk of substrate jams and printhead crashes; see [Assisted manual load on page 63](#).

1. At the printer's front panel, press , then **Load**.

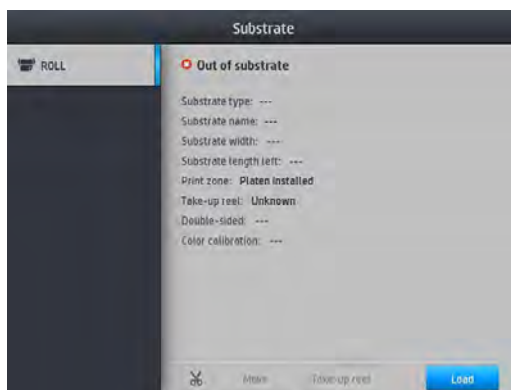

Alternatively, press , then **Substrate load > Load roll**.

2. The load configuration screen appears.

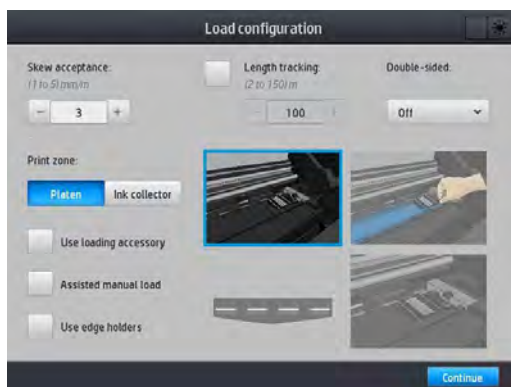

- Skew acceptance: The available values are between 1 and 5, default 3. The printer warns you if the skew is over the limit you have set, but you can still choose to continue loading.
- Length tracking: If you check the box and give the length of your roll, the printer reduces the spare paper when printing and tells you the remaining length. See [Substrate length tracking on page 79](#).
- Double-sided: May be **Off**, **Side A**, or **Side B**. See [Double-sided printing \(365 and 375 only\) on page 77](#).
- Print zone: Choose **Platen** or **Ink collector**. See [Ink collector \(365 and 375 only\) on page 55](#).
- Use loading accessory. See [Loading accessory \(365 and 375 only\) on page 59](#).
- Assisted manual load. See [Assisted manual load on page 63](#).
- Use edge holders. See [Edge holders on page 65](#).

When you have made your choices, instructions are displayed.

3. Carefully insert the leading edge of the substrate above the smooth black roller, making sure the substrate remains taut during the process. Avoid rewinding the substrate manually, unless the printer asks you to do so.

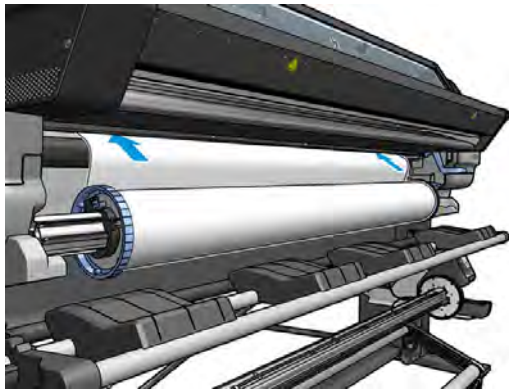

**⚠ WARNING!** Take care not to insert your fingers inside the printer's substrate path.

The printer beeps when it detects and accepts the leading edge of the substrate.

4. Select the category and name of the substrate you are loading.

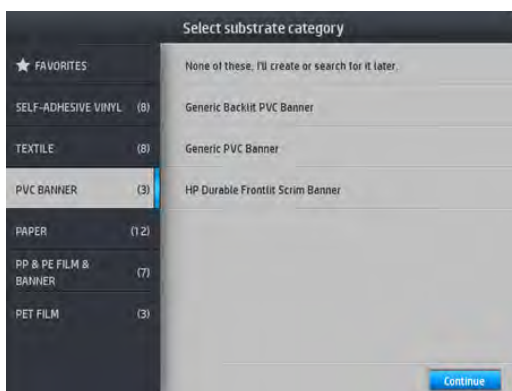

You can also search by favorites, or you can select **None of these, I will choose it later:** by accessing the substrate library after completing the loading procedure. See [Substrate presets on page 89](#).

**📝 NOTE:** You should select the same substrate name that you are using in your RIP software.

5. The printer checks the substrate in various ways and may ask you to correct problems with skew or tension.

6. Wait until the substrate emerges from the printer, as shown below.

**⚠ WARNING!** Take care not to touch the curing zone or the platen, which may be hot.



Risk of burns

For more safety information, please see [Safety precautions on page 3](#)



**📝 NOTE:** If you have an unexpected problem at any stage of the substrate loading procedure, see [Substrate cannot be loaded successfully on page 80](#).

7. If you are loading transparent substrate without opaque borders, you are asked to enter the width of the substrate and the distance of the right edge from the printer's side plate (as indicated by the ruler on the front of the curing module).
8. If you have chosen double-sided printing and side B—see [Double-sided printing \(365 and 375 only\) on page 77](#)—the printer will look for the black reference line at this point. If it fails to find the line, it will ask a few questions.
9. The printer calibrates the substrate advance.
10. The printer indicates that it is ready for printing.

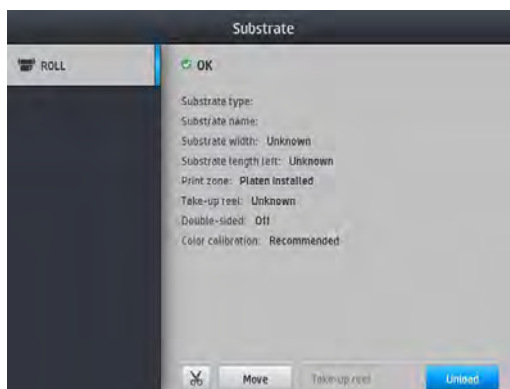

Take care not to cover the top fans.

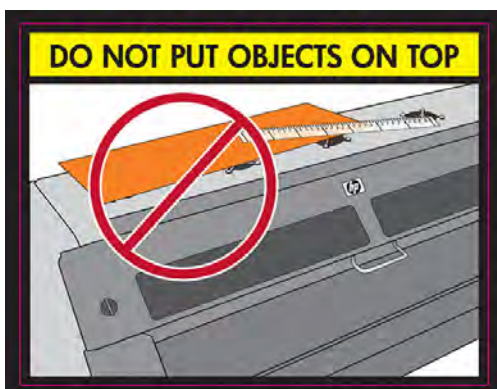

## Ink collector (365 and 375 only)

The ink collector should be used instead of the platen in the following cases:

- Whenever you intend to print on a porous substrate. See [Porous substrates on page 46](#).
- Whenever you intend to print to the edges of the substrate without leaving any margin (full bleed printing).

The platen and the ink collector both come in two parts (left and right). To install the ink collector, first unlock and remove the two parts of the platen. Then install the two parts of the ink collector in their place.

The ink collector comes with blue consumable parts that should be attached to the ink collector. They can be attached before or after installing the ink collector in the printer; but before loading any substrate. To attach these parts, put them vertically into the ink collector and press until the two snaps on each part have clicked into place.

 **TIP:** You are recommended to use the take-up reel with the ink collector. See [Take-up reel on page 69](#).

 **WARNING!** Avoid moving parts. Handle fragile parts with care. You are recommended to wear gloves.



Moving part



Fragile



Wear gloves

For more safety information, please see [Safety precautions on page 3](#)

### Install the ink collector

1. The platen and the ink collector both come in two parts (left and right). Unlock the platen using the two blue locks, located at the left and right of the printer.

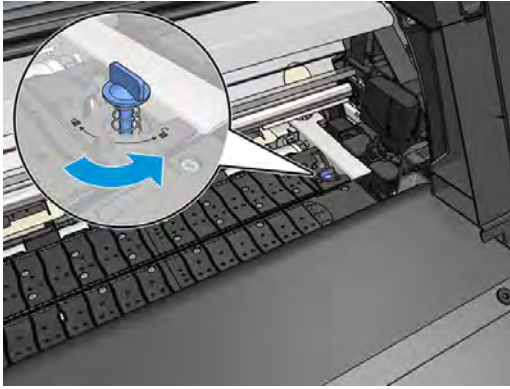

2. Remove both parts of the platen in the same way.

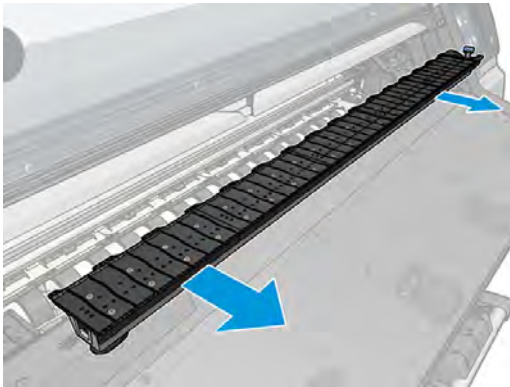
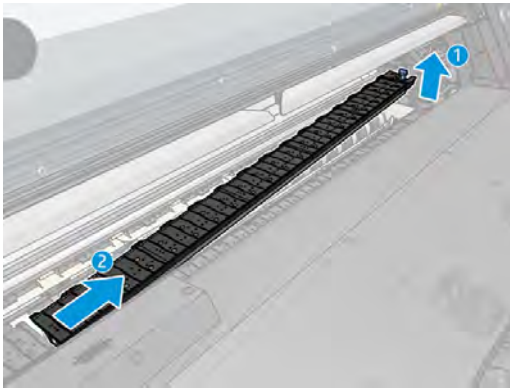

3. Place the two parts of the ink collector into the printer.

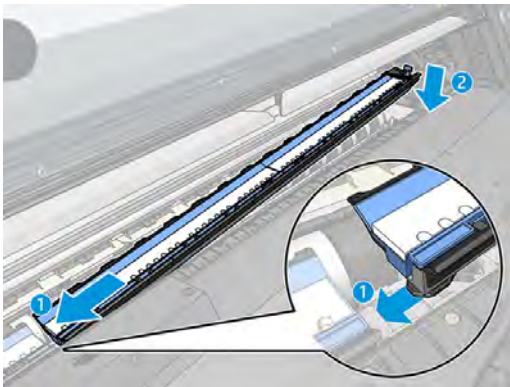

4. Ensure that the locks are locked and that there is no obstruction in the printing path.

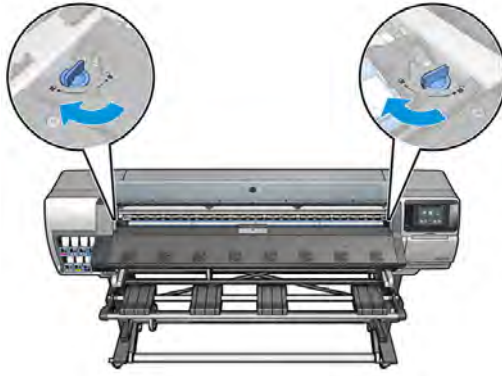

5. Install the output platen protectors before loading substrate.
- a. Insert an output platen protector on one side of the output platen.

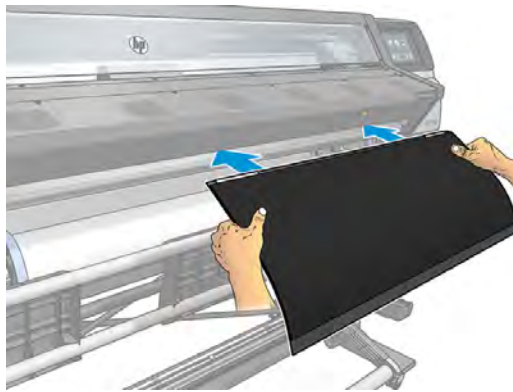

- b. Open the window.

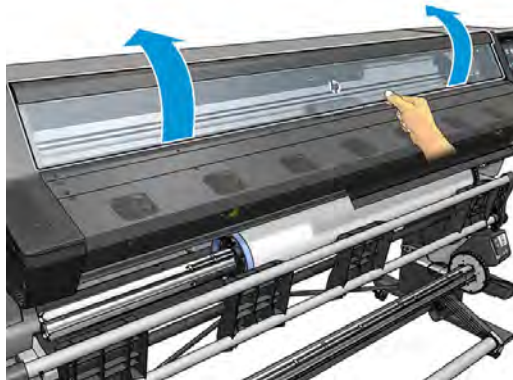

- c. Insert the tabs between the plastic piece and the metal.

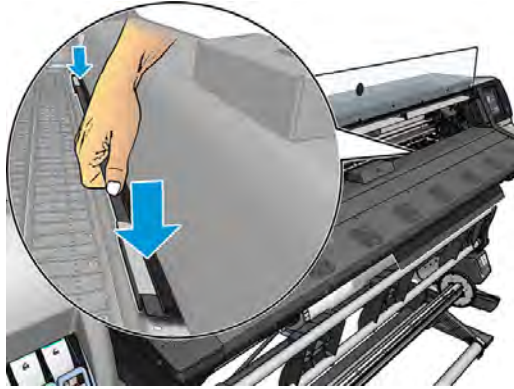

- d. Make sure the platen protector is well positioned and straight.

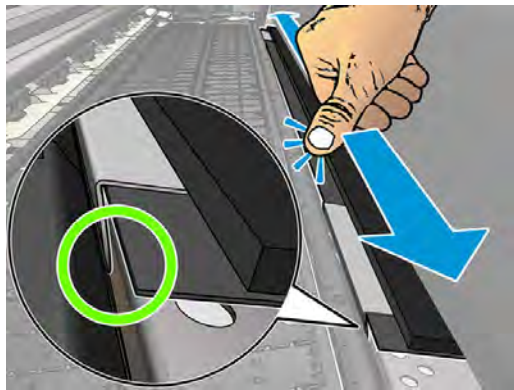

- e. Do the same on the other side.

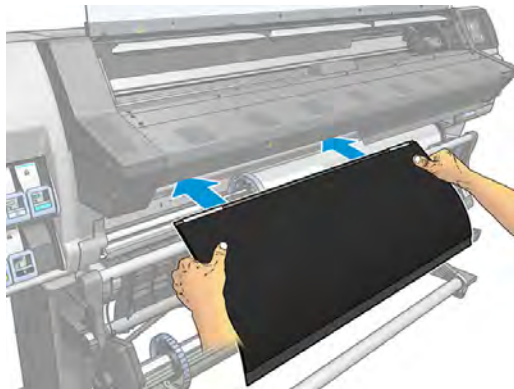

Follow the same method to re-install the platen when required. Attach the velcro to the back of the output platen until tight.

### Replace the blue ink collector consumables

The length of substrate that you can print with the same ink collector consumables depends on the porosity of the substrate and the quantity of ink used on the print. If you see that the substrate is dirty when printing, stop printing and change the ink collector consumables. Failure to do so could cause some parts of the printer to malfunction.

1. You are recommended to wear the gloves that are included in the kit.
2. Press both snaps with your thumbs and lift the ink collector consumables vertically out of the printer.
3. Dispose of the dirty ink collector consumables.



4. Ensure that the ink collector is clean. If not, clean it with a damp cloth.
5. Place the new ink collector consumables into the printer vertically, starting on the right. You will hear a click when the snaps have been inserted.

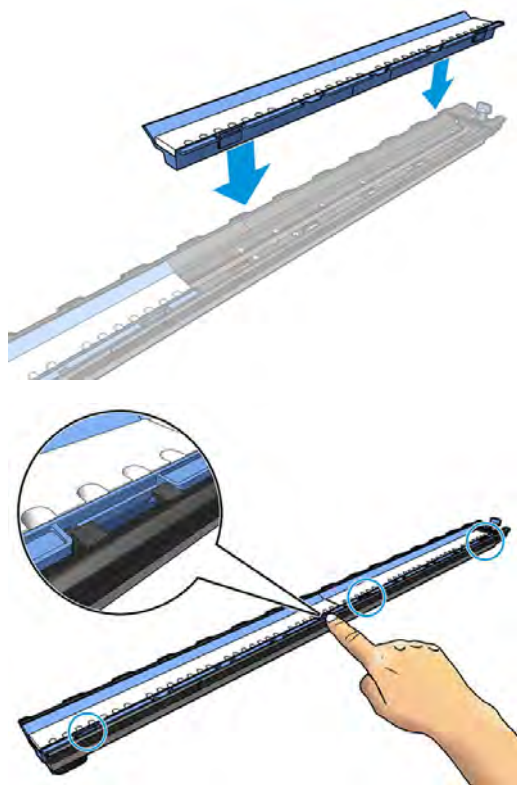

## Loading accessory (365 and 375 only)

The loading accessory is designed to help in loading banner/textile/mesh substrates. It is recommended when loading such substrates, but not obligatory.

 **NOTE:** The edge holders can be used whether or not you decide not to use the loading accessory.

1. Before loading the substrate, check the **Use loading accessory** box in the Load Configuration screen on the front panel.

 **IMPORTANT:** Also check the **Assisted manual load** box, to prevent crashes between the carriage and the load accessory. See [Assisted manual load on page 63](#).

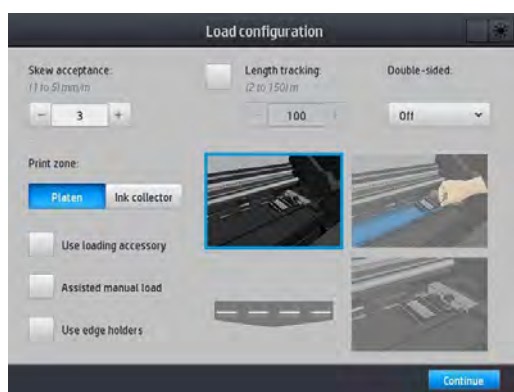

2. Lay the textile loading accessory on the loading table and flip forward enough of the white flaps to cover the width of the substrate.

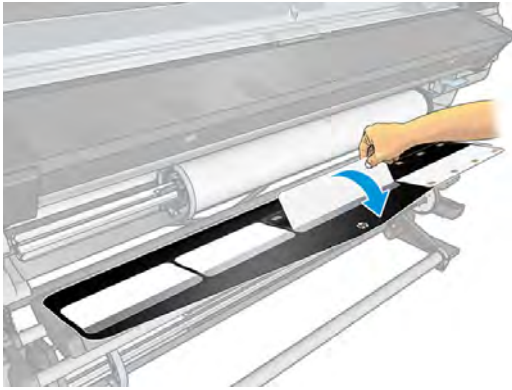

3. Pull some of the substrate from the roll and put the leading edge on the loading accessory.

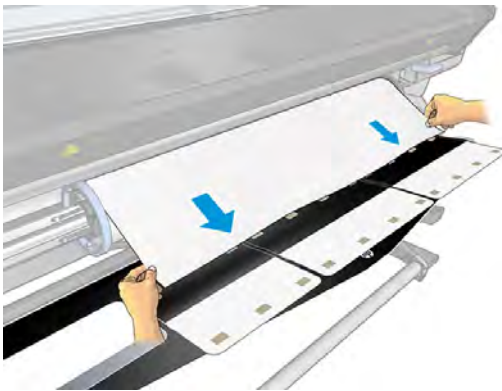

4. Flip the white flaps back to cover the leading edge of the substrate. The black patches are magnetic and grip the substrate.



5. Lift the loading accessory and the leading edge of the substrate together.



6. Load the substrate manually, see [Assisted manual load on page 63](#).

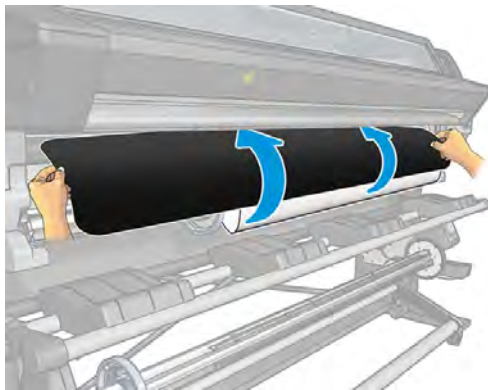

7. The loading accessory passes through the printer's substrate path with the substrate.

**⚠ WARNING!** Take care not to touch the curing zone or the platen, which may be hot.



Risk of burns

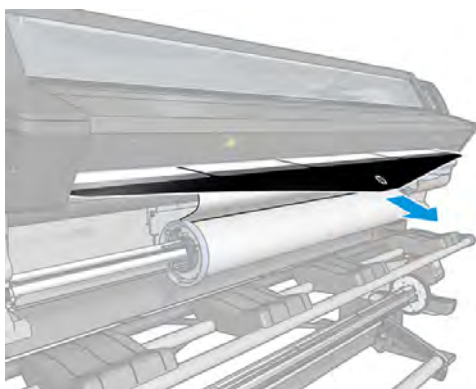

For more safety information, please see [Safety precautions on page 3](#)

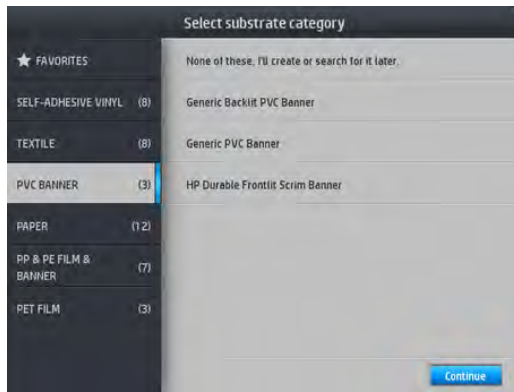

8. Select the category and name of the substrate you are loading.





 **NOTE:** You should select the same substrate name that you are using in your RIP software.

 **TIP:** When loading very thin substrates, always select the substrate type as **Banner** to minimize the vacuum pressure applied while loading; when loading very thick substrates, always select the substrate type as **HP Photo-realistic Poster Paper** (in the Paper category) to maximize the vacuum pressure. After loading and before printing, go to the front panel and change to the correct type for the substrate you are loading: press , then **Substrate > Change loaded substrate**.

9. After passing through the printer, the loading accessory can be removed by hand.



10. The printer checks the substrate in various ways and may ask you to correct problems with skew or tension.

 **NOTE:** You can specify the maximum permitted amount of skew at the front panel: press , then **Substrate > Substrate handling options > Max skew setting**. You can also do this on the Load Configuration screen.

11. If you are loading transparent substrate without opaque borders, you are asked to enter the width of the substrate and the distance of the right edge from the printer's side plate (as indicated by the ruler on the front of the curing module).
12. If you have chosen double-sided printing and side B, the front panel may ask a question if the reference line is not found. See [Double-sided printing \(365 and 375 only\) on page 77](#).
13. The printer calibrates the substrate advance.

 **NOTE:** You are recommended to use the take-up reel; however, it is not obligatory.

## Assisted manual load

The assisted manual load procedure should be used in the following cases:

- The substrate is unusually thin or unusually thick.
- The substrate has ragged edges.
- The substrate tends to curl at the edges.
- The printing side of the substrate faces outwards.
- You intend to use the loading accessory.

In other cases, you are recommended to use the normal loading procedure. See [Load a roll into the printer on page 52](#).

To start the assisted manual load procedure, you need to have a roll loaded on the spindle. See [Load a roll onto the spindle on page 47](#).

The normal minimum substrate width is 23 inches (584 mm). To load substrates down to a minimum width of 10 inches (254 mm), go to the front panel and press , then **Substrate > Substrate handling options > Enable narrow substrate**. With this option, print quality is not guaranteed.

1. Start the substrate loading procedure as usual (see [Load a roll into the printer on page 52](#)), and make sure to check the **Assisted manual load** box in the load configuration screen.

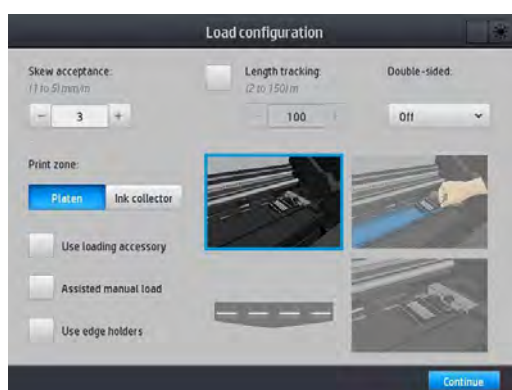

You can alternatively begin at step 2, in which case the load configuration screen will appear with this checkbox checked after you lift the pinch lever. Press **Continue** before taking the next step.

2. Lift the substrate pinch lever as far up as it will go.

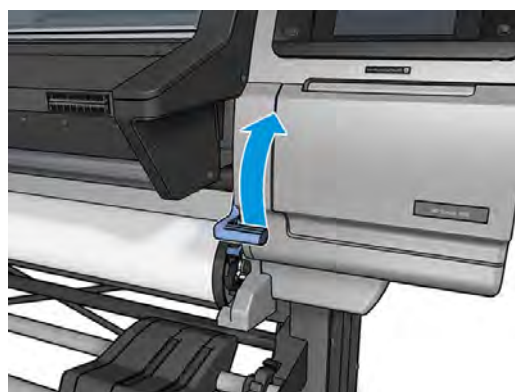

3. Carefully insert the leading edge of the substrate above the smooth black roller, making sure the substrate remains taut during the process. Avoid rewinding the substrate manually, unless the printer asks you to do so.

- Continue to feed the substrate until it reaches the printing platen. Open the window to help pull the substrate through, and keep feeding the substrate at least until the leading edge is at the same height as the substrate roll. Align the right edge of the substrate with the right edge of the roll.

**⚠ WARNING!** Do not touch the printer's curing enclosure. Even after you have opened the window latch, which disconnects the power to the curing modules, the internal surfaces could be hot. Also beware of getting your fingers trapped in the substrate path.



Risk of burns



Risk of trapped fingers

For more safety information, please see [Safety precautions on page 3](#)

**💡 TIP:** If the substrate you are using tends to curl, keep feeding the substrate until the edge is out of the printer. You are also recommended to use the take-up reel, or to disable the cutter from the front panel if not using the take-up reel.

- Once the substrate is correctly fed into the printer, pull down the substrate pinch lever as far as it will go.

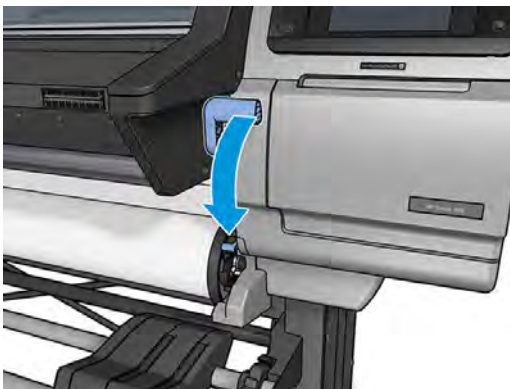

- Select the category and name of the substrate you are loading.

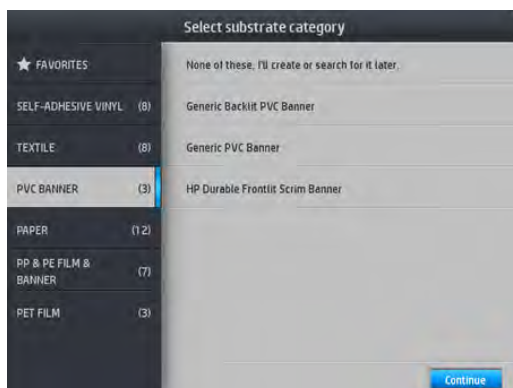

The rest of the assisted load procedure is the same as in the normal load procedure. See [Load a roll into the printer on page 52](#).

## Edge holders

The edge holders are designed to prevent the edges of the substrate from rising while printing is in progress. They are recommended only when the edges of the substrate tend to lift up and touch or damage the printheads. They can be used with the platen or with the ink collector. When not in use, they should be stored outside the printer.

If they are needed often, they can be stored inside the printer, to the left and right of the print platen, to avoid substrate jams when loading the next substrate.

 **NOTE:** The edge holders extend 7 mm over the edge of the substrate. You should set a minimum left and right margin of 7 mm (0.3 in) in the RIP when using edge holders, otherwise the printer could try to print on the edge holders.

If you choose to use them, you should move them into position when prompted by the front panel (this prompt appears when the **Use edge holders** checkbox has been checked). Open the window, place the edge holders, then close the window.

The edge holders should be placed on the platen so that they slightly overlap the left and right edges of the substrate. There are marks on the printer to show where to place them.

The edge holders for each printer model are the same, but they are installed in different ways.

 **WARNING!** Avoid moving parts. Handle fragile parts with care. You are recommended to wear gloves.



Moving part



Fragile



Wear gloves

For more safety information, please see [Safety precautions on page 3](#)

### Place edge holders for the 315 or 335 printer

1. There is a hole on the left for the edge holders. Insert an edge holder vertically into the hole.

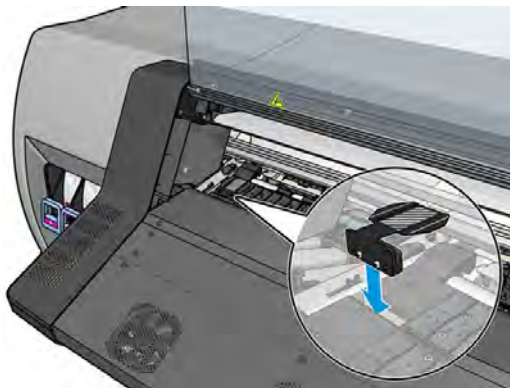

2. Slide the edge holder into its correct position.

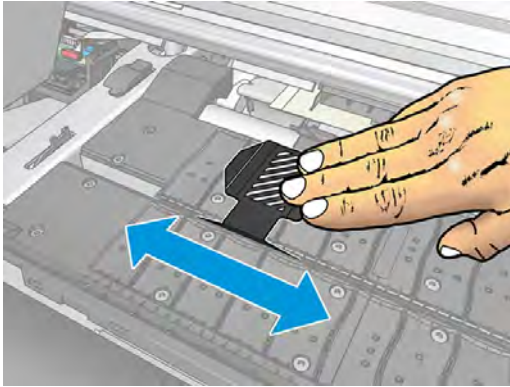

3. Repeat with the other edge holder.

### Place edge holders for the 365 or 375 printer

1. Remove the platen module or ink collector on one side of the printer.

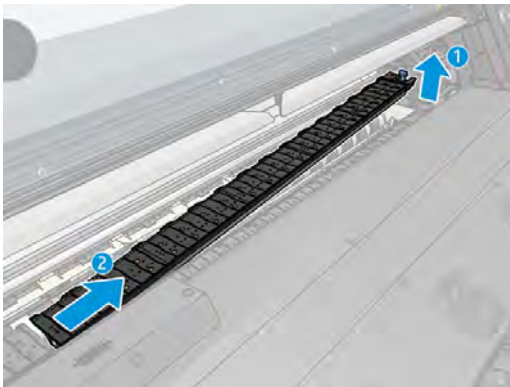
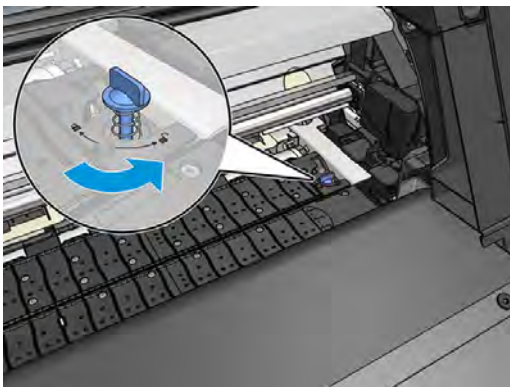



2. Slide the edge holder onto the platen module or ink collector, and adjust its position: on the left, as far to the left as possible; on the right, as far to the right as possible.

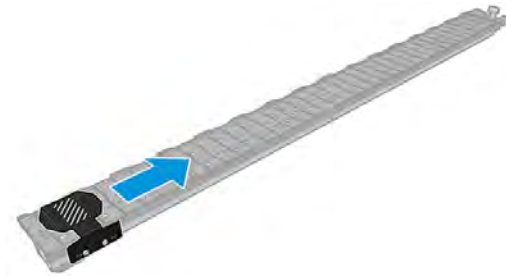

3. Put back the platen module or ink collector with the edge holder in place.

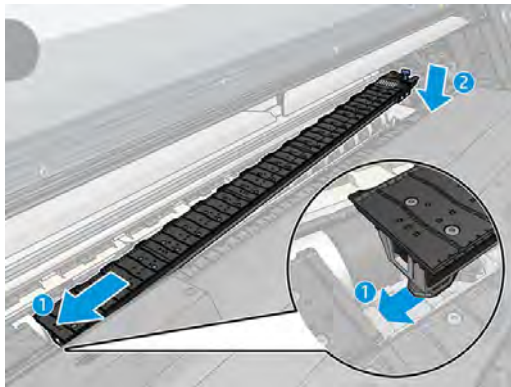

4. Repeat with the platen module or ink collector on the other side.

## Align the substrate

When the substrate has been loaded, align it with the white line on the edge holder. Misalignment could result in a substrate jam, or damage to the substrate or to the printheads.

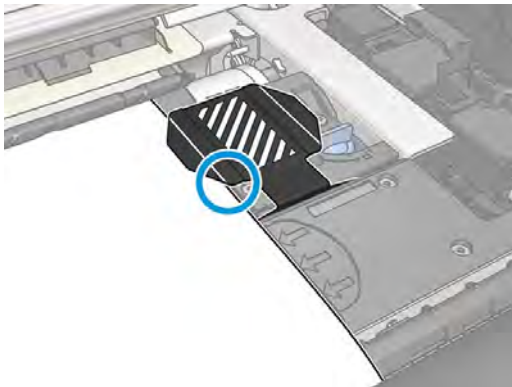

## Load a cut sheet into the printer

The printer is designed to be used with rolls of substrate. It is possible to load cut sheets into the printer, but print quality cannot be guaranteed, and you may have some difficulty in avoiding skew.

- The sheet should be at least 1067 mm (42 in) long.
- Load the sheet by following the normal roll loading procedure (automatic or manual, depending on the substrate).

- During the loading procedure, the printer tries to detect the winding direction of the roll by turning the spindle in both directions. When the substrate is not attached to the spindle, the following message appears.

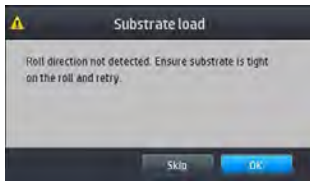

- A cut sheet is likely to be loaded with excessive skew, and the printer may not be able to correct it automatically. If the skew as measured by the printer exceeds 3 mm/m, you are recommended to reload the sheet. However, if the skew is tolerable, you can consider skipping the automatic skew correction. To do so, when prompted, choose **Continue with current skew**.

## Unload a roll from the printer

1. If you used the take-up reel during printing, unload the printed roll from the take-up reel. See [Unload the take-up reel on page 76](#).

2. On the printer's front panel, press , then **Unload**.

Alternatively, you can press , then **Substrate > Unload substrate**.

3. If the printer has been tracking the length of the substrate, the front panel displays the remaining length so that you can note it for future reference. See [Substrate length tracking on page 79](#).

Press **OK** to continue.

4. When the printer has rewound the roll, lift the spindle lock lever.

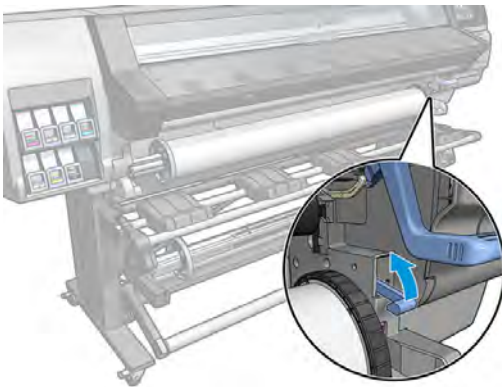

5. Remove the spindle from the printer, pulling out the right end on the right side of the printer first.

---

 **WARNING!** Do not insert your fingers into the spindle supports while removing the spindle.

---



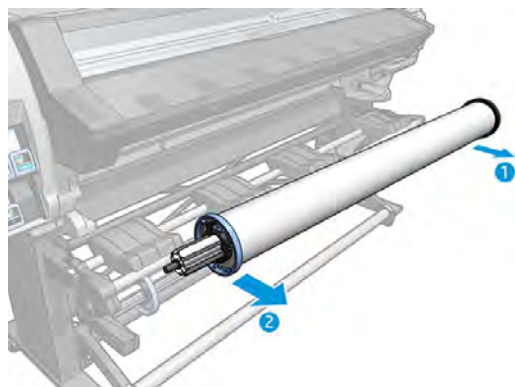

## Take-up reel



### Tension bar

When in use, the take-up reel requires a dangling loop of substrate weighed down by a tension bar. The tension bar can be moved with the take-up reel buttons or by using the **Move paper** or **Rewind paper** options in the front panel.

### Load a roll onto the take-up reel

 **NOTE:** Take-up reels with 51 mm (2 in) or 76 mm (3 in) diameter can be used.

1. On the printer's front panel, press , then **Take-up reel**.

Instructions are displayed on the screen; slide your finger laterally across the front panel to follow the instructions to the end.

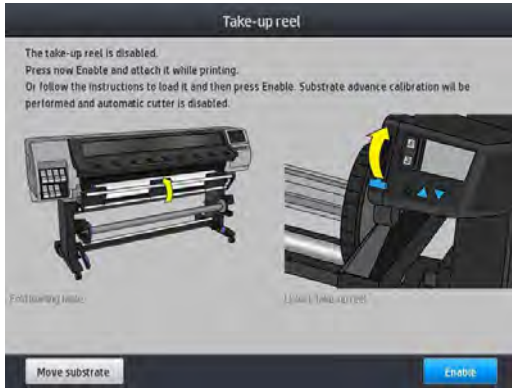

2. If you decide to load the take-up reel during printing, familiarize yourself with the procedural steps before pressing the **Enable** button. Loading the take-up reel during printing requires you to complete the procedure while the printer is feeding and printing substrate. Loading the take-up reel during printing saves approximately 1.5 m (4.9 ft) of substrate.

**TIP:** You are recommended to keep the take-up reel winding-direction switch in the off position (see [Unload the take-up reel on page 76](#)) to avoid unwanted movements when loading the take-up reel while printing. Once you have the leading edge of the substrate attached to the core, and the substrate is straight, switch the winding-direction switch to position 1 or 2, as you prefer. Setting 1 winds the substrate so that the printed image faces in, setting 2 winds the substrate so that the printed image faces out.

The following steps assume that you have decided to load immediately. If you decide to load later, during printing, you must complete the same operations without guidance from the front panel.

3. For easier access to the take-up reel, lift the loading table into its upright position.

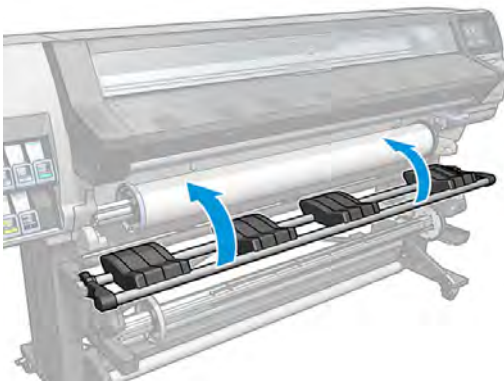

4. Unlock the take-up reel by pushing its lever to the uppermost position.

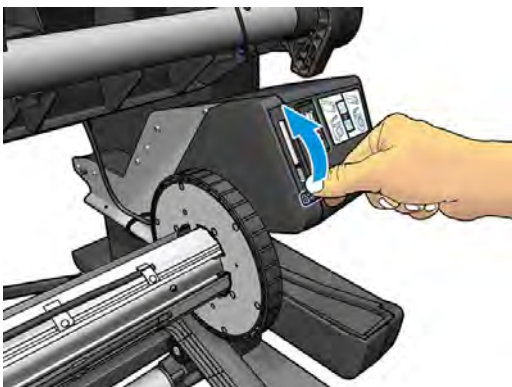

5. Remove the take-up reel.

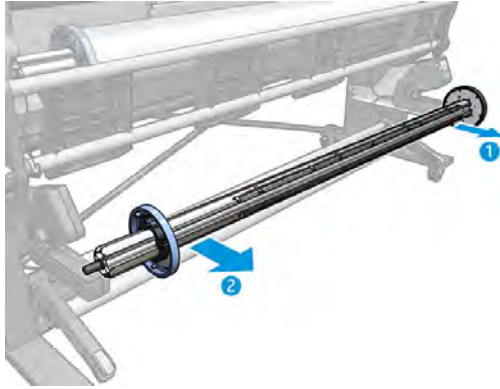

6. For the 335, 365, and 375 printers, lift the lever in each case to remove both of the stops from the take-up reel; they will not be used.

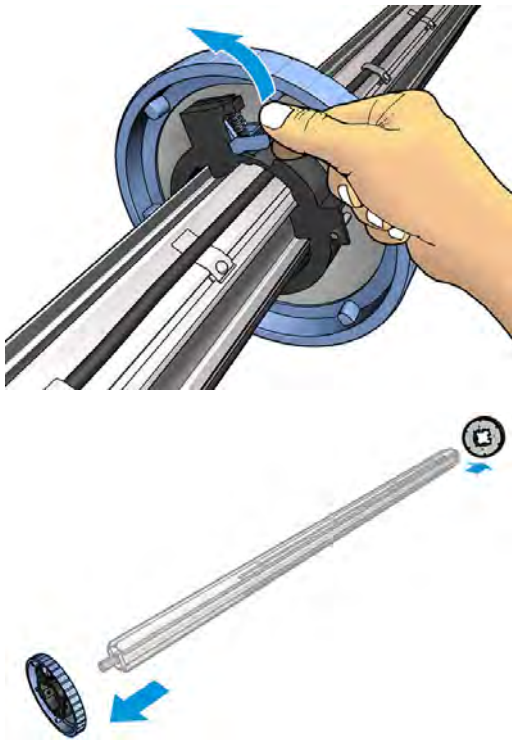

7. Load the core onto the take-up reel. The core should be at least as wide as the substrate.

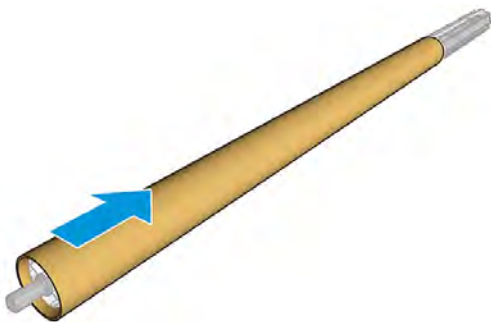

8. Load the take-up reel into the printer by pushing firmly on both ends.

**⚠ WARNING!** Take care not to get your fingers trapped.



Risk of trapped fingers

For more safety information, please see [Safety precautions on page 3](#)

---

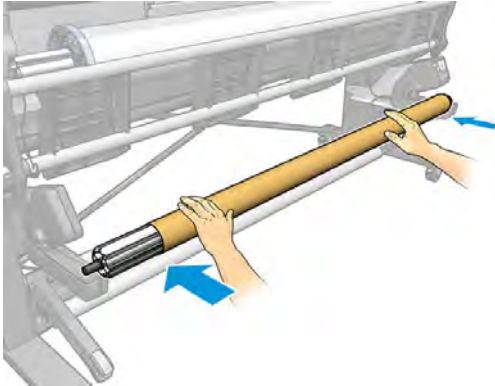

9. Advance the substrate by pressing the **Move substrate** button on the front panel. Make sure that the substrate passes in front of the loading table.

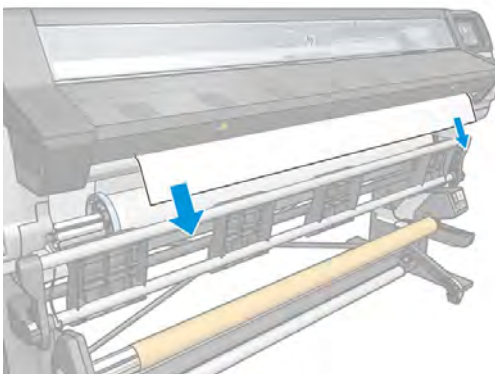

10. Pull down the center of the substrate's leading edge to straighten the substrate. Do *not* attempt to pull more substrate out of the printer.

 **NOTE:** If you are loading the take-up reel *during* printing, you do not need to pull the substrate taut. Tape the substrate to the core when an adequate length of substrate has fed from the printer after printing begins.

 **WARNING!** Do not touch the printer's curing enclosure, which could be hot.

---



Risk of burns

For more safety information, please see [Safety precautions on page 3](#)

---

11. Adjust the position of the core on the take-up reel so that it is aligned with the substrate.

12. Tape the leading edge of the substrate to the core in the center, then at each side. Make sure that the substrate is straight.

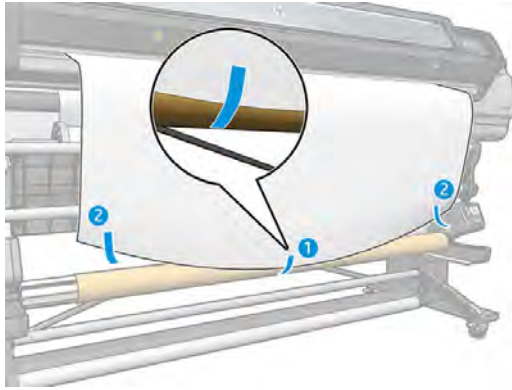

 **NOTE:** Depending on whether you want to print the images facing in or out, place the tape accordingly. See below.

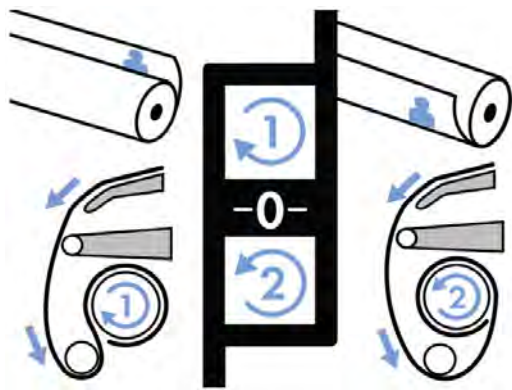

13. Press the button on the front panel to advance the substrate, creating a loop.

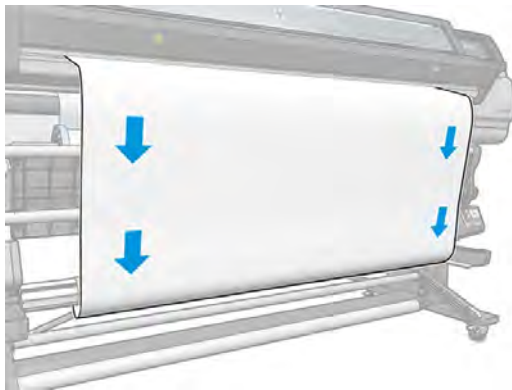

14. Press the blue arrow on the take-up reel motor to rotate the reel one full turn. This will help to support the weight of the tension bar.

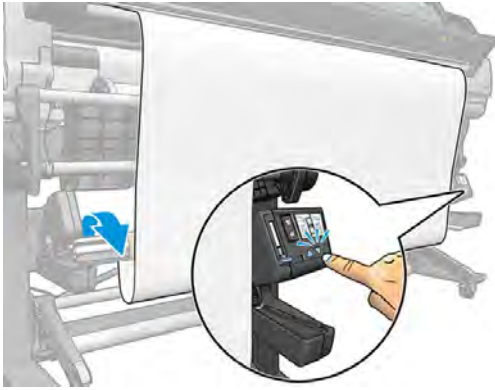

15. Press the button on the front panel to advance the substrate again.

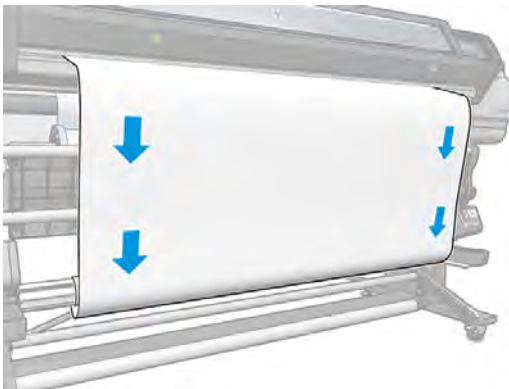

16. Gently lower the loading table, to avoid wrinkles and improve winding.

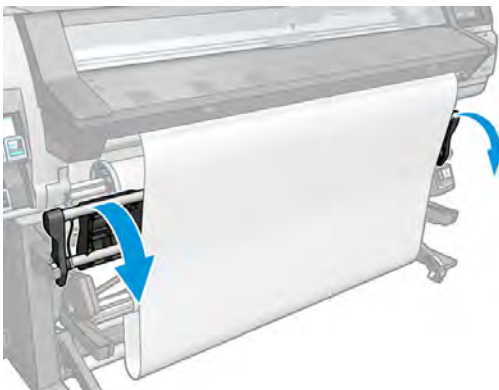



17. Carefully insert the tension bar. This is essential: the take-up reel will not function correctly without it.

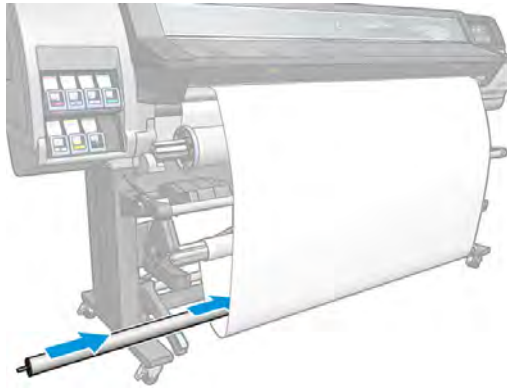

18. Fit the tension bar into the supports at either side.

**⚠ WARNING!** Take care not to get your fingers trapped.



Risk of trapped fingers

For more safety information, please see [Safety precautions on page 3](#)

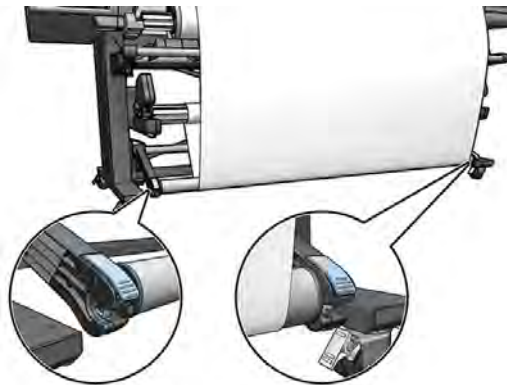



19. Use the winding-direction switch on the take-up reel motor to select the winding direction. Setting **1** winds the substrate so that the printed image faces in. Setting **2** winds the substrate so that the printed image faces out.

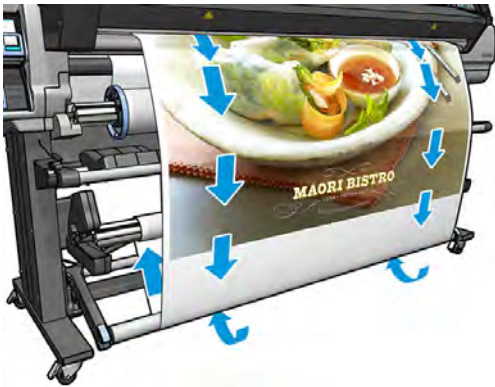

20. Press the **Enable** button on the front panel. The printer advances and calibrates the substrate.
21. The following image shows how the printer looks when it is operating. As substrate is fed from the printer, it drops down to the tension bar, over the diverter, then down again to the take-up reel.



- 
-  **NOTE:** When the take-up reel is in use, the substrate is not automatically cut after each print.
-  **NOTE:** For the 335, 365, or 375 printer: If the take-up reel is loaded during printing, recalibrate the substrate-advance sensor for optimal print quality. At the front panel, press , then **Image quality maintenance > Substrate advance calibration > OMAS calibration**.
- 

## Unload the take-up reel

-  **WARNING!** Take care not to get your fingers trapped.
- 



Risk of trapped fingers

For more safety information, please see [Safety precautions on page 3](#)

---

1. On the printer's front panel, press , then **Take-up reel**.

The printer allows you to move the substrate to facilitate cutting.

2. Switch the winding-direction switch to the off position. The switch is in the off position when it is centered (in other words, when the switch is neither in position 1 nor position 2).
3. To remove the tension bar, first lift the support, then press the lever.
4. Use the winding button on the take-up reel motor to wind the excess substrate around the take-up reel.
5. Cut the substrate with scissors.
6. While holding the substrate, use the winding button on the take-up reel motor to wind the remainder of the substrate around the take-up reel.
7. Unlock the take-up reel by pushing its lever to the uppermost position.

8. Remove the take-up reel from the printer, pulling out the end on the right side of the printer first.
9. To remove the roll from the printer after you have unloaded the take-up reel, see [Unload a roll from the printer on page 68](#).

## Double-sided printing (365 and 375 only)

The printer can be used to print on both sides of the substrate, in the following way.

---

 **NOTE:** The print should be at least 28 cm (11 in) wide, otherwise the printer will not be able to find the reference line when printing the second side.

---

### Outline

1. Tell the printer or the RIP that you intend to print on both sides.  
  
Double-sided printing can be selected in your RIP software or at the printer's front panel. The RIP setting takes precedence: if double-sided printing is explicitly turned on or off in the RIP software, the front panel setting is ignored.
2. The printer prints the content that you want to appear on the first side. After each job, the printer prints a black reference line that is used to align the matching job on the second side.
3. After all side A jobs have been printed, cut and unload the substrate.
4. Reload the cut substrate upside down and starting at the end. The reference line marking the end of the first side should be face down and near the leading edge.
5. The printer finds the reference line, and uses it to start printing the second side in the right place.

---

 **NOTE:** If you try to move the substrate while printing on either side, the front panel asks for confirmation, because any such movement prevents correct alignment between the two sides.

---

### Double-sided printing in detail

1. Load the substrate in the normal way for the substrate you are using.
2. Optionally, select the side to print in the Double Side menu on the Load Configuration screen.

If the RIP supports double-sided printing, select double-sided printing in your RIP software.

---

 **NOTE:** The automatic cutter and the extra top/bottom margin are both disabled during double-sided printing.

---

3. Send one or more jobs to be printed on the first side. Before printing the first job, the printer may advance the substrate by about 0.5 m (20 in) so that the second side can be completely cured. After each job, the printer prints a black reference line that is used to align the matching job on the second side.

---

 **NOTE:** The chance of visible misalignment between the two sides increases with the length of the job. For this reason, in double-sided printing you are recommended not to print any single job that is longer than 3 m (10 ft). Visible misalignment may also be caused by skew.

---

4. After printing all side A jobs, advance the substrate a little by going to the front panel and pressing



, then **Move substrate**.

- If you plan to attach the substrate to the take-up reel before printing the second side, advance the substrate enough to achieve this.
- If you plan to attach the substrate to the take-up reel while printing the second side, advance the substrate about 10 cm (4 in).

5. Cut the substrate, either manually or by going to the front panel and pressing , then **Cut**. Before cutting, ensure that the total length of the cut substrate is more than 2 m (6 ft 7 in), otherwise you may be unable to load it successfully.

 **NOTE:** The **Cut** command will not work if the cutter is disabled: that is, if , **Substrate** > **Substrate handling options** > **Cutter** is set to **Off**.

6. Press , then **Substrate unload**.
7. Reload the substrate with the already-printed side facing up as it enters the printer, and with the reference line near the leading edge. Reload if necessary until the printer finds less than 1 mm/m skew.

 **TIP:** Although it is not strictly necessary, you may find it quicker to use the manual loading procedure as an initial approximation, and then allow the printer to find the reference line more accurately. See [Assisted manual load on page 63](#). If you use only the automatic loading procedure, the printer may take some time to find the reference line.

8. Select side B from the Double Side menu in the Load Configuration screen, so that the printer will search for the black reference line when the substrate is loaded.

 **NOTE:** If enable autoline detection is off, the automatic search is disabled, and the printer asks you to find the correct position manually.

9. The printer searches for the reference line on the substrate. If it fails to find it, the front panel asks you to move the substrate using the [Rewind substrate](#) and [Advance substrate](#) keys until the reference line is aligned with the permanent line on the platen. You may find it useful to mark where the reference line is on the other side of the substrate.

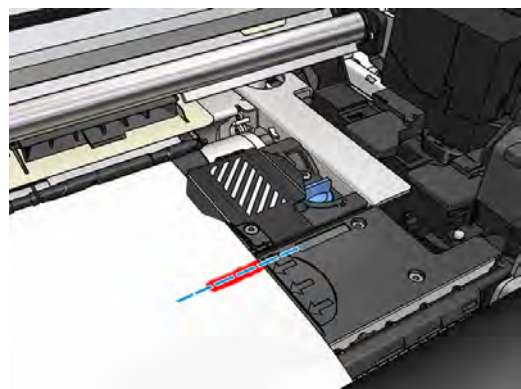
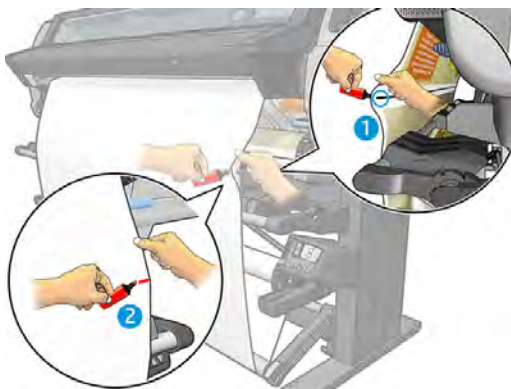

## View information about the substrate

On the front panel's home screen, press .

The following information appears on the front panel, if any substrate is loaded:

- The substrate type
- The substrate name
- The substrate width in millimeters (estimated by the printer)
- The remaining length of the substrate, if known
- The printing zone (platen or ink collector)
- The take-up reel status
- Whether double-sided printing is selected
- The color calibration status

If no substrate is loaded, the message **Out of substrate** appears.

The same information appears on the Embedded Web Server's Supplies page.

## Change substrate width and right edge position

If the substrate edges are not correctly found by the printer, they can be changed from the front panel by pressing , then **Substrate > Substrate handling options > Substrate width** or **Right edge position**.

 **TIP:** Bear in mind that automatic edge detection will not be attempted again until the next substrate load.

## Substrate length tracking

The substrate length tracking feature enables you to keep track of how much substrate remains on the roll.

1. When the roll is first loaded onto the printer, you have the option (in the Load Configuration screen) to enter the length of substrate on the roll. The amount of substrate that is subsequently used is then tracked.
2. When the substrate is unloaded, the front panel displays the amount remaining so that you can note it for future reference.

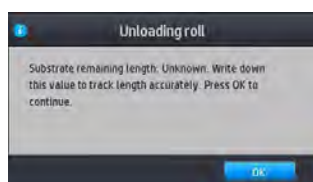

The remaining length of substrate is always displayed in the Substrate area of the front panel. This information may also be displayed in your RIP.

## Cut substrate

This option is available from the printer's front panel. If you press , then the scissors icon, the printer normally advances the substrate 10 cm (3.9 in) and cuts it.



**NOTE:** If the cutter is disabled (, then **Substrate handling options > Cutter > Off**), the printer advances the substrate but does not cut it.



**NOTE:** Some banners and textiles cannot be cut.

## Bypass job start safety

The job start safety mode is activated by default so that the leading edge of the substrate does not crash under the curing system.

If you print with the substrate hanging from the front of the printer, or using the take-up reel, you may want to deactivate this option to improve throughput (not recommended). To do that, press , then **Substrate > Substrate handling options > Bypass job start safety**.

## Store the substrate

The following are tips for storing substrate:

- Always keep unused rolls wrapped in the plastic wrap to prevent discoloration and dust accumulation. Rewrap partially used rolls if they are not being used.
- Do not stack rolls.
- Allow all substrates to adapt to room conditions out of the packaging for 24 hours before printing.
- Handle film and glossy substrates by the edges or wear cotton gloves. Skin oils can be transferred to the substrate, leaving fingerprint marks.
- Keep the substrate tightly wound on the roll throughout the loading and unloading procedures. If the roll starts to unwind, it can become difficult to handle.

## Substrate cannot be loaded successfully

Here are some suggestions to try if you cannot load the substrate successfully.

- Reread the loading instructions, and make sure that you are following them. See [Handle the substrate and troubleshoot substrate issues on page 40](#).
- When loading a textile substrate, remember to use the loading accessory, and select **Use loading accessory** in the configuration screen.
- If automatic loading is unsuccessful, try assisted manual loading instead.
- The substrate might be loaded at an angle (skewed or mislocated). Make sure that the right edge of the substrate is aligned with the roll on the input spindle.
- The substrate might be crumpled or warped, or have irregular edges. See [Substrate is deformed or wrinkled on page 84](#).
- If the substrate jams in the substrate path to the platen, the leading edge of the substrate might not be straight or clean. Remove the initial 2 cm (1 in) of substrate from the roll and try again. This might be necessary even with a new roll of substrate.
- Make sure that the spindle is correctly inserted.
- Make sure that the substrate is correctly loaded on the spindle.

- Make sure that the substrate is wound tightly.
- If the substrate is curled, and you see a **Clean OMAS** or **disable it at the RIP** alert, advance the substrate until the whole print zone is covered, then go to the front panel and press , then **Image-quality maintenance** > **Substrate-advance calibration** > **OMAS calibration**.

## Substrate is mispositioned

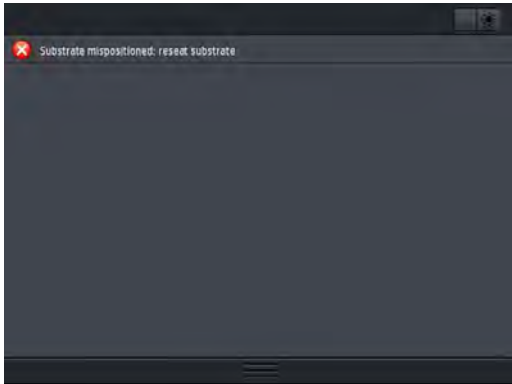

If you see the above display on the front panel, proceed as follows.

1. Lift the substrate lever.
2. Manually reposition the substrate on the platen.
3. Lower the substrate lever.
4. Repeat the above steps until the front panel displays the **Ready** message.

## Substrate has jammed



When a jam occurs, the **Possible substrate jam** message usually appears in the front panel, with one of several error codes (see [Front-panel error codes on page 166](#)).

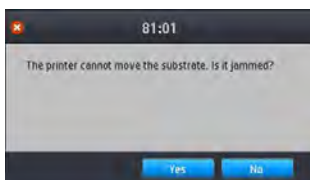

If you are trying to load a very thin or very thick substrate, or a textile, remember to follow the special procedure for loading such substrates. See [Loading accessory \(365 and 375 only\) on page 59](#).

## Check the substrate path

This problem can occur when a roll has finished and the end of the roll is stuck to the cardboard core. If this has happened, cut the end of the roll away from the core. Then feed the substrate through the printer, and load a new roll.

Otherwise:

1. Turn off the printer at the front panel, then also switch off the power switch at the rear.
2. Open the printer window.

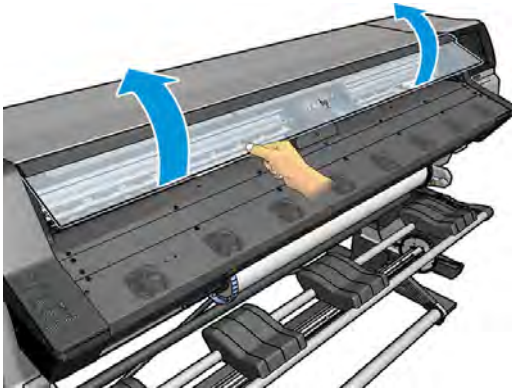

3. Cut the substrate where it enters the printer, and rewind the input roll.
4. Try to move the printhead carriage out of the way.

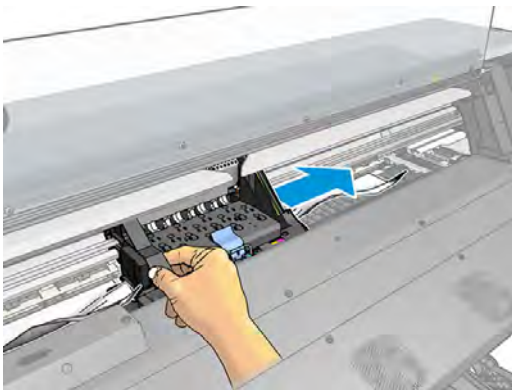

5. Lift the substrate pinch lever as far up as it will go.

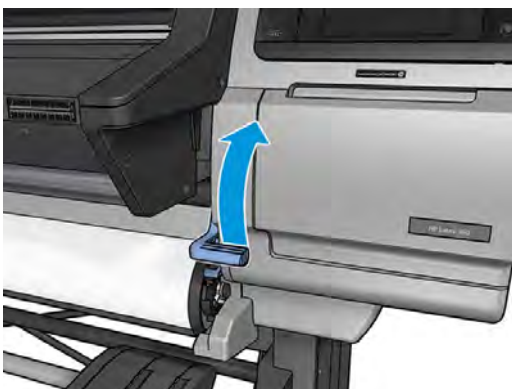

6. Carefully remove as much as possible of the jammed substrate from the top of the printer. Cut the substrate if necessary.



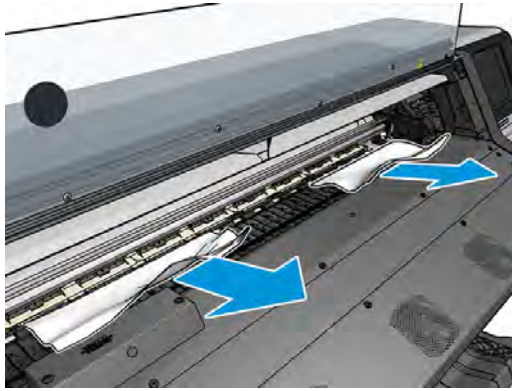

**⚠ CAUTION:** Try to avoid pulling the substrate out through the input path, because this reverses the normal direction of movement, and could damage printer parts.

**⚠ WARNING!** Do not touch the printer's curing enclosure, which could be hot.



Risk of burns

For more safety information, please see [Safety precautions on page 3](#)

7. Lower the substrate pinch lever.
8. Make sure that there are no pieces of substrate left in the printer. In particular, check in and under the curing module, and in the substrate path.
9. Close the window.
10. Turn on the printer.
11. Reload the roll.
12. If some substrate continues to cause an obstruction within the printer, it can often be cleared by loading a rigid substrate type into the printer.
13. If you find that you have print-quality problems after a jam, try realigning the printheads. See [Align the printheads on page 134](#).

## Avoiding substrate jams while printing

Substrate jams may be caused by loading the substrate with too much skew: do not ignore the warning message that appears during the loading procedure in this case.

They may also be caused by not enough vacuum suction in the printing zone. If you decide to increase the suction, do not exceed the following limits: 20 mmH<sub>2</sub>O for banners, 35 mmH<sub>2</sub>O for vinyl, and 50 mmH<sub>2</sub>O for other substrate families.

If you experience jams only at the beginning of a print, try the following suggestions.

- Disable the automatic cutter.
- Go to the front panel and press , then **Substrate handling options** > **Extra bottom margin** and **Extra top margin**. Set both margins to 100 mm. If that is not enough, try higher values.

- Increase the vacuum level in steps of 10 mmH<sub>2</sub>O. Do not exceed the following limits: 20 mmH<sub>2</sub>O for banners, 45 mmH<sub>2</sub>O for vinyl, and 60 mmH<sub>2</sub>O for other substrate families.

Consider reducing the vacuum percentage at the front of the print zone for thin substrates.

- Increase the number of passes.
- Make sure that the substrate is stored in the same room in which the printer is located.
- Try using the substrate edge holders.

## Substrate is deformed or wrinkled

If your substrate is deformed or wrinkled by the curing process, change the temperature settings before printing the next job, and advance the substrate, using the **Move substrate** option in the front panel's **Substrate** menu, so that the next job will be printed on undamaged substrate.

If the problem appears only at the beginning of the print, try the following suggestions.

- Disable the automatic cutter.
- Go to the front panel and press , then **Substrate handling options** > **Extra bottom margin** and **Extra top margin**. Set both margins to 100 mm. If that is not enough, try higher values.
- Increase the vacuum level in steps of 10 mmH<sub>2</sub>O. Do not exceed the following limits: 20 mmH<sub>2</sub>O for banners, 45 mmH<sub>2</sub>O for vinyl, and 60 mmH<sub>2</sub>O for other substrate families.
- Increase the number of passes.
- Make sure that the substrate is stored in the same room in which the printer is located.

## Substrate has shrunk or expanded

During the printing process, some substrates may shrink, while others may expand. If this happens, the dimensions of the print will not be correct.

As a general rule, you can expect the following percentages of shrinkage:

- Banner: less than 2%
- Self-adhesive vinyl: less than 0.5%
- Backlit: less than 0.5%
- Paper: less than 0.5%
- PP & PE synthetics: less than 1%

The framing problem may be solved by printing a sample and adjusting the size of the image in the RIP. You may reuse this value for all your future prints with the same substrate, although special care must be taken when using banners, as the shrinkage may vary up to 1% depending on the amount of ink used in the print.

You can expect the following variations from one print to another:

- Banner: less than 0.3%
- Self-adhesive vinyl: less than 0.1%
- Backlit: less than 0.05%

- Paper: less than 0.1%
- PP & PE synthetics: less than 0.4%

To solve the tiling problem and improve the repeatability of the printed size, you are recommended to ensure that the substrate-advance sensor is enabled in the RIP's substrate preset, as this will improve the stability of the prints over time. You are also recommended to tile together areas with similar amounts of ink. If this is not possible, print the areas with different amounts of ink as different jobs and modify the length of the job with less ink in the RIP to match its size with the job with high ink content.

Some RIPs may provide a scaling option that allows you to compensate easily for substrate shrinkage or expansion; see your RIP documentation.

See also [Variable Front Tension Kit on page 121](#).

## Substrate has bow deformation

The following substrates may suffer from bow deformation during printing, as a result of which the print will appear curved.

- Self-adhesive vinyl substrates (some specific calendared vinyls only)
- Cellulose-based poster papers with no backing nor coating, including HP Photorealistic

This deformation may be particularly noticeable in the following applications.

- Printing images that will later be cut automatically or manually. When there is bow deformation, cutters that are aligned on the sides may lose alignment in the center.
- Poster printing, if the poster is framed or mounted on a straight surface.

The example below shows an original image, the substrate suffering from bow deformation, and the resulting print, also suffering from bow deformation.

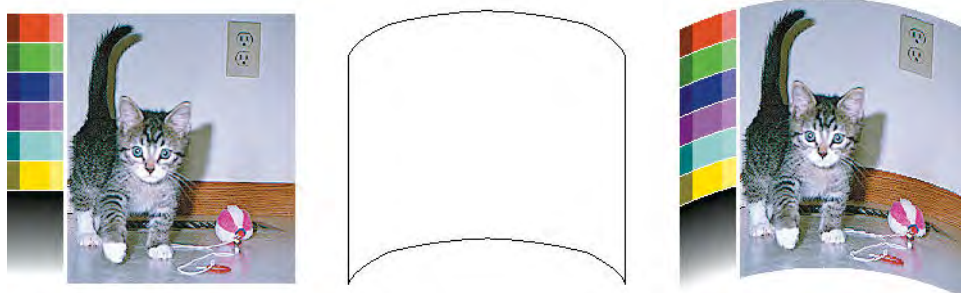

You can compensate for this effect and restore the original shape of your image: select a correction value from -6 to +6 in your RIP or in the substrate library. To apply the correction in your RIP, please refer to your RIP documentation.

The chosen value should represent the vertical distance that the centre of the substrate has moved with respect to the left and right edges. If the deformation moves the center of the substrate in the direction of substrate advance, the correction value should be negative; if in the reverse direction, the correction value should be positive. In practice, the required correction value is normally negative.

---

**TIP:** You can use the diagnostic image provided in <http://IPaddress/hp/device/webAccess/diagnostic/StraightnessOptimizationPlot.pdf> (where *IPaddress* is the IP address of your printer) to help you to determine the correct value to apply.

---

## Substrate is sticky and causes smears and crashes

Some substrates may become sticky when heated by the curing system; especially banners and double-sided banners under high temperatures. To avoid the problem, HP recommends reducing the curing temperature as much as possible and reducing the front tension (avoid using the take-up reel if possible).

The ink collector included in the 365 and 375 printers is designed both to collect ink from textiles and porous substrates and to reduce the friction of the substrate against the output platen. Install the ink collector as described in [ink collector \(365 and 375 only\) on page 55](#) before printing on a sticky substrate.

## Automatic cutter does not work

The automatic cutter is turned off in any of the following cases.

- When it has been manually disabled from the RIP or from the front panel. To disable the cutter from the front panel, press , then **Substrate handling options > Cutter > Off**.
- When printing on textiles, PVC banners, or any other substrate types that it cannot cut, the RIP disables the cutter.
- When the take-up reel is enabled.



**TIP:** You can disable the take-up reel from the front panel by pressing , then **Take-up reel >**

**Enable take-up reel.**

- During double-sided printing (side A or B).
- When printing internal prints (see [Request the printer's internal prints on page 19](#)).

## Take-up reel substrate jam

If the substrate is severely damaged on the take-up reel, do not use the printer's cutter to cut and remove the substrate. Instead, cut the substrate manually as close as possible to the printer window, then remove the roll.

If the problem remains after removing the substrate jam, unload the take-up reel from the front panel and load it again.

## Take-up reel does not wind

Predictably, if the take-up reel is not winding as anticipated, the printed output is likely to end up on the floor. If the printer recognizes a problem with the take-up reel, it interrupts the print job until the issue is corrected. If the printer does not recognize a problem, the job continues to print. The following table highlights possible issues and solutions.

Take-up reel LED status	Issue	Print job interrupted?	Possible cause	Possible solution
Blinking quickly	Take-up reel is not winding	Yes	The tension bar is in its lower position because the winding direction is not correct.	Change the winding direction using the winding-direction switch on the take-up reel motor. You may need to use the blue arrow buttons to collect substrate from the floor.

Take-up reel LED status	Issue	Print job interrupted?	Possible cause	Possible solution
Blinking slowly	Take-up reel is not winding	No	The sensor cables are loose or unplugged.	Ensure that the sensor cables are correctly secured.
Solid red	Take-up reel is not winding	No	There is too much resistance on the take-up reel motor.	Ensure that nothing is blocking the substrate path or the tension bar.
Solid green	Take-up reel is not winding	No	The winding-direction switch on the take-up reel motor is Off or in the wrong position.	Ensure that the switch is On, and select the correct winding direction (1 or 2).
Solid green	Take-up reel is winding in the wrong direction	No	The winding-direction switch on the take-up reel motor is in the wrong position.	Change the switch to the correct position.

---

## 4 Substrate settings

- [Substrate presets](#)
- [Online search](#)
- [HP Media Locator](#)
- [Generic presets](#)
- [Clone a substrate preset](#)
- [Modify a substrate preset](#)
- [Add a new substrate](#)
- [Delete a substrate preset](#)
- [Faster printing](#)
- [Color calibration](#)
- [Color consistency between different printers \(365, 375\)](#)
- [ICC profiles](#)
- [Improve color consistency when tiling](#)

## Substrate presets

Each substrate type has its own characteristics. To obtain the best print quality, the printer has to adapt its printing parameters to each different substrate type. For example, some may need more ink and some may require higher temperatures for curing. A specification of the correct printing parameters for a particular substrate type is called a *substrate preset*.

The substrate preset contains a color profile in International Color Consortium (ICC) format, which describes the color characteristics of the combination of printer, inks, and substrate. It also contains information about other parameters (such as curing temperature, vacuum pressure, and substrate-advance compensation) that are not directly related to color. Substrate presets (also known as Open Media System or OMES packages) are installed in the printer, and automatically copied to supported RIP software whenever it is connected to the printer.

The printer comes with substrate presets for the most commonly used generic substrates. Some presets may come preinstalled in your printer (such as HP Vinyl presets); use them only with the substrates for which they were created. For other substrates, presets named Generic are recommended over other preinstalled presets. However, the best performance can be achieved only with presets made specifically for your substrate. There are various ways to obtain more presets:

- Use the **Online search** function on the front panel or the HP Media Locator on the Web to browse, search, and download a specific preset for your substrate.
- Download a preset from the RIP vendor's website, or from the substrate vendor's website.
- Use a generic preset designed for your substrate category, even though it is not fine-tuned for the specific substrate type. Bear in mind that generic substrate settings cannot be modified; instead, the preset can be cloned and then modified.
- Clone (copy) a preset for a similar substrate, and edit it as necessary.
- Create a new preset, starting from scratch, using the **Add new** button.

If you can find a ready-made preset for your specific substrate, you are recommended to use it.

## Online search



You can search online for a substrate preset by using the **Online search** function within the Substrate Library front-panel menu. The printer connects to the HP Media Locator database on the Internet and allows you to search all available substrate presets for your particular printer model, including HP and third-party substrate brands. Hundreds of different substrate presets may be available, and the database of substrate presets is continuously updated and expanded. You will always get the most up-to-date content in this way.

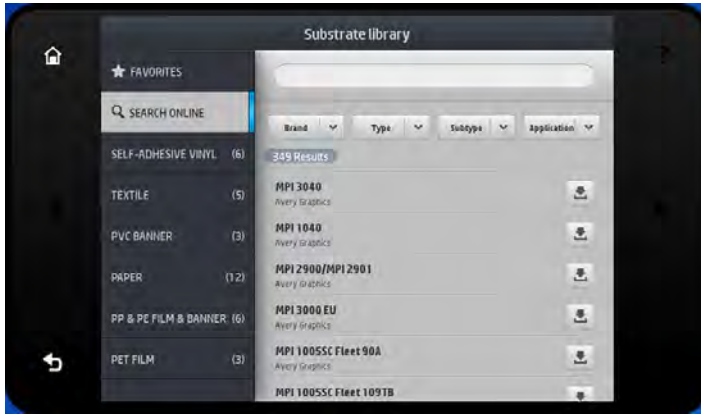

When the printer is connected to the database (this may take a few seconds), a list of all available substrate presets for your printer model is displayed. You can browse the list by scrolling it, and get details on any preset by pressing its name. Besides browsing, there are two additional ways to look for presets: free-text search and filters.

- Free-text search allows you to type in any text using an on-screen virtual keyboard; all substrate presets containing that text in any part of their name or description will be displayed. For example, if you search for "vinyl" then substrate descriptions such as "self-adhesive vinyl" or "vinyl banner" will match and be displayed. The search is case-insensitive; that is, "vinyl" will match both "vinyl" and "Vinyl".
- Filters are available for brand, type, sub-type, and application. When a value is selected for a given filter, only the matching substrate presets will be displayed. For example, if you select "HP" from the brand filter, only HP substrate presets will be displayed. The effect of using more than one filter is to narrow the search to the combination of the filter settings. For example, if you choose "HP" from the brand filter and "Self-Adhesive Vinyl" from the Type filter, only substrate presets for HP Self-Adhesive Vinyl substrates are displayed.

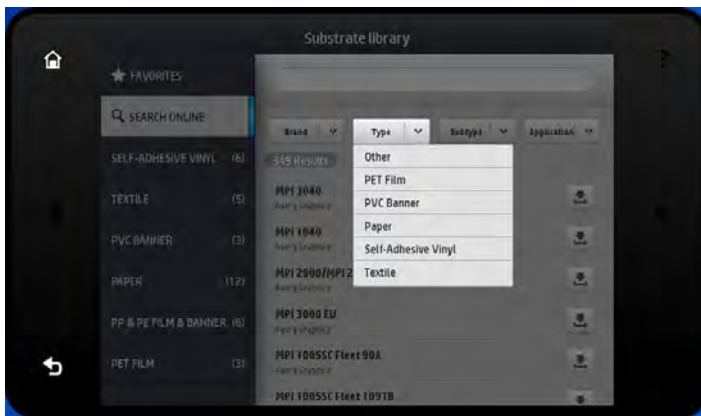

Once you have located the substrate preset of your choice, pressing its download icon will queue it for automatic download and installation in the background. You can select as many substrate presets as you want for download and installation (they will be processed in the order that they were selected). You can return to another part of the Media Manager or another front panel screen at any time after queuing presets for download, and this will not interrupt the download and installation process.



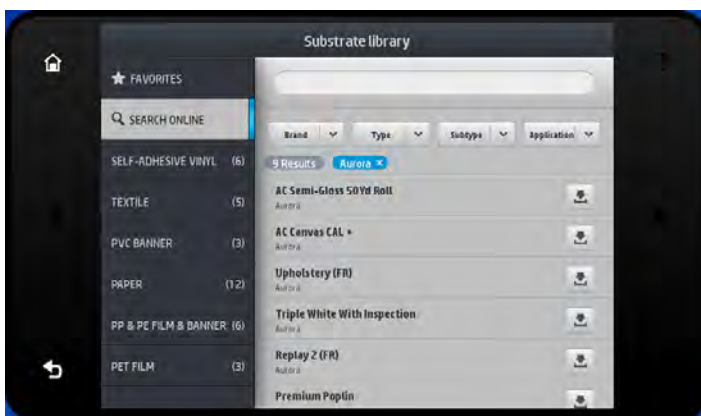

Once a substrate preset has been downloaded in the background, it is checked and installed on the printer's hard disk. During checking and installation, a full-screen message is shown on the front panel. This message disappears when checking and installation is complete.

The new substrate preset now appears in the Substrate Library together with all previously installed and factory-provided presets, and is ready for use.

Some supported RIPs may implement a similar online substrate-preset search function accessing the same HP Media Locator database. Whether you use the printer's front panel search or RIP-based search does not matter: the end result is the same. Supported RIP software synchronizes its substrate preset list with the printer, so that printer and RIP will always have the same list.

## HP Media Locator

The HP Media Locator database of substrate presets can also be accessed from a Web browser by visiting <http://www.hp.com/go/mediasolutionslocator>. This provides access to the database for different regions, printer models, applications, suppliers, substrate types, and so on.

When you have located the substrate preset of your choice, you can download it to your computer. To install the preset into the printer with which you want to use it, use the printer's Embedded Web Server. Navigate to the **Setup > Substrate presets management > Import** screen.

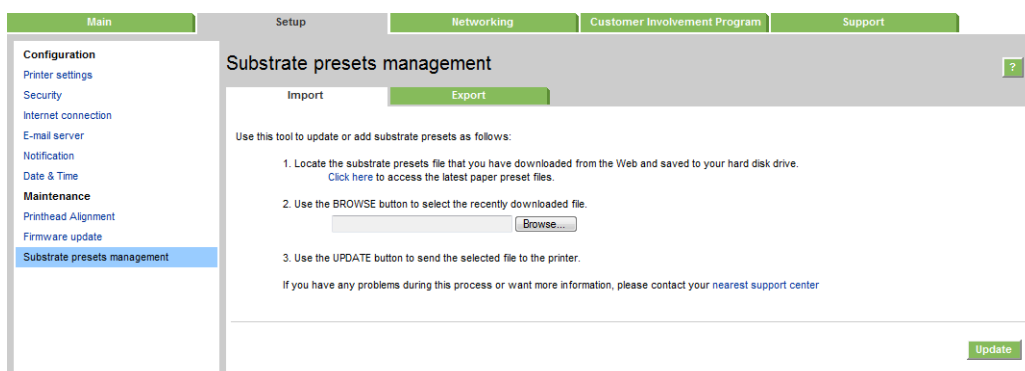

Click **Browse** to browse to the substrate preset file that you have previously downloaded to your computer, then click **Update** to install the preset in your printer.

The Embedded Web Server also allows you to export substrate presets from your printer for use with another printer of the same model. When importing a previously exported substrate preset, you may see a message warning you that the package is not signed (only packages downloaded from the HP Media Locator internet database are digitally signed, as a form of authentication); you can then ignore the warning and continue with the installation, or abort the installation.



## Generic presets

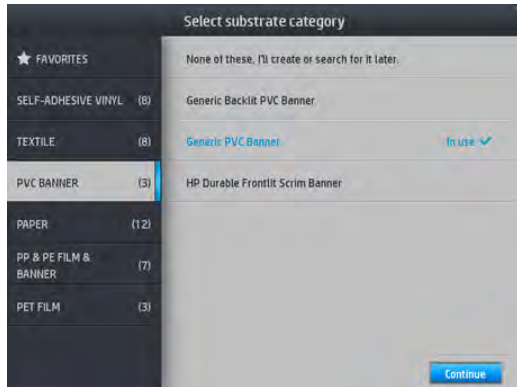

Generic presets are each designed for a whole substrate category, rather than for a particular substrate type. They cannot be edited, erased, saved, color-calibrated or ICC profiled; but they can be cloned. Therefore, if you would like to modify a generic preset in any way, you should first clone it and then work on the clone, which is fully editable.

The printer provides generic presets for the supported substrate categories: see [Supported substrate categories on page 43](#).

## Clone a substrate preset



You may wish to clone and edit a preset for various reasons:

- To assign a name of your own choice to the preset
- To adjust the preset to the precise characteristics of your substrate
- To adjust the preset to your intended use of the substrate, which may range from highest-quality printing to fast production output.

To clone a substrate preset, follow these steps:

1. Select a preset in the Substrate Library.

- Click **Clone** to clone the preset, and enter a name for the new preset.

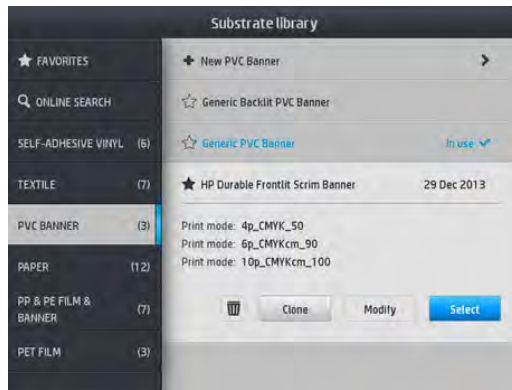

## Modify a substrate preset

You can modify a preset by pressing **Modify**.

Then click the  icon of the print mode that you want to modify; or click **Add new print mode**. You can delete or change the name of any print mode; although you should keep at least one print mode.



 **NOTE:** You can define up to six print modes.

 **NOTE:** The number of passes in an existing print mode cannot be changed. If you want to change the number of passes, create a new print mode.

 **NOTE:** You are not allowed to create two print modes with the same number of passes, the same efficiency mode, and the same color saturation.

To change the values, you must print a test plot. Check it and choose the number in the pull-down color-saturation menu that matches your preferences in terms of curing and drying. If none of the options are good enough, try changing the temperature and reprint. You can also change the substrate advance settings.

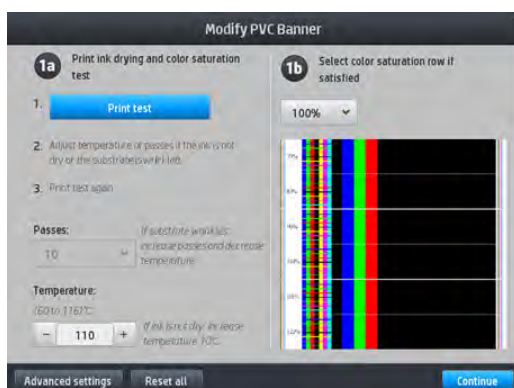

## Add a new substrate

If you cannot find a ready-made preset for your substrate, and prefer not to use a generic preset or edit an existing preset, you can make your own preset from scratch.

The Add New Substrate wizard guides you to work out the best settings for your substrate. It first requests some information about the substrate and your intended use of it, then prints some test prints and asks you to evaluate them. From this information, it creates the new preset.

1. Ensure that the printer is in the Ready state.
2. Stop the job queue.
3. Load your new substrate, selecting the most similar substrate when asked to do so; or select **None of these**.
4. When the substrate has been loaded, go to the Substrate Library on the front panel, and choose the substrate category in the left column of the Substrate Library screen (**PVC BANNER** in this example), then click **+ New PVC banner** at the top of the right column. Your new preset will be based on a generic preset; If there are multiple generic presets in that category, the front panel asks you to choose one of them.

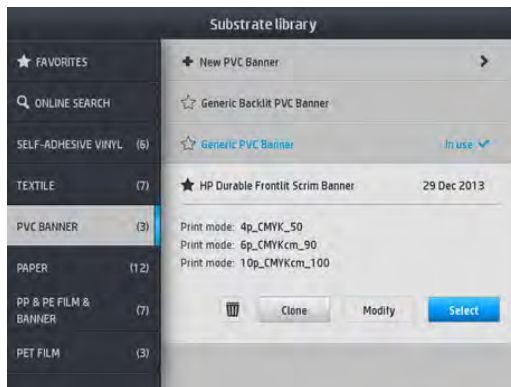

5. The front panel guides you through the subsequent steps to create your new preset.

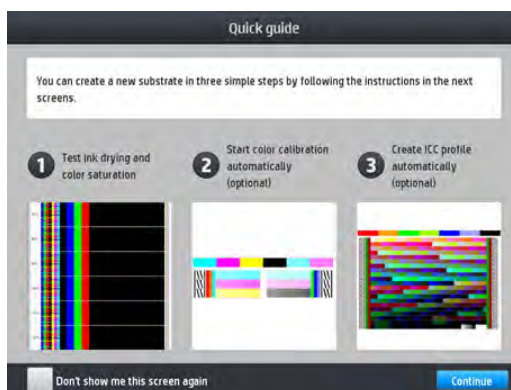

6. The following screen is displayed:

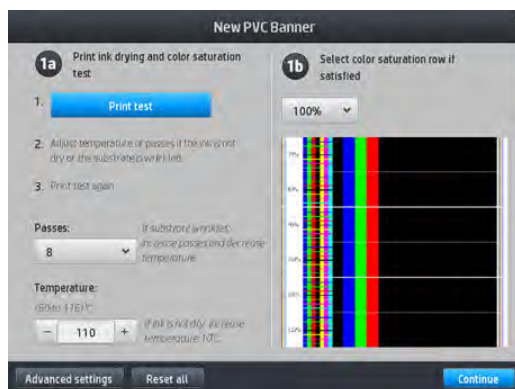

7. Press the blue button to produce the ink drying and color saturation test print; then continue adjusting the settings and printing again until you are satisfied with the result.

 **NOTE:** You can omit this step if you already know the settings that you want to use.

8. If you cannot reach a satisfactory result, you may want to press **Advanced settings** and try adjusting those settings, which are intended for people who understand their implications.

To go back to the previous screen, press .

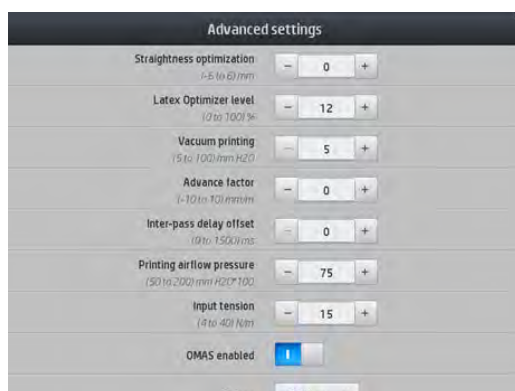

- Straightness or bow compensation: Allows you to compensate for barrel-shaped substrate deformation. The value represents the distance that the centre of the substrate has moved with respect to the left and right edges. See [Substrate has bow deformation on page 85](#).
- Latex optimizer level: If you have bleed or coalescence, you can increase the optimizer level until you see a significant impact on gloss or color saturation.
- Vacuum printing: Sets the vacuum value in the print zone to hold the substrate flat. Increase if the substrate suffers from crashes or smears, decrease if you see banding or graininess.
- Advance factor: Use only when printing without the substrate-advance sensor, to increase or decrease the substrate advance in each carriage pass.
- Inter-pass delay offset: The time delay between passes to allow for smoother drying. Increase the delay if you have seen banding on your prints.
- Input tension: Substrate rewinder tension, increase in case of wrinkled substrate in the print zone.
- OMAS enabled: Automatic substrate-advance tracking and correction.
- Efficiency mode: Print four (CMYK) or six (CMYKcm) colors.

 **NOTE:** You cannot change this setting after the print mode has been created.

- When you have finished, press **Continue** to perform color calibration.

 **NOTE:** ICC profiles are created for the 365 and 375 printers only.

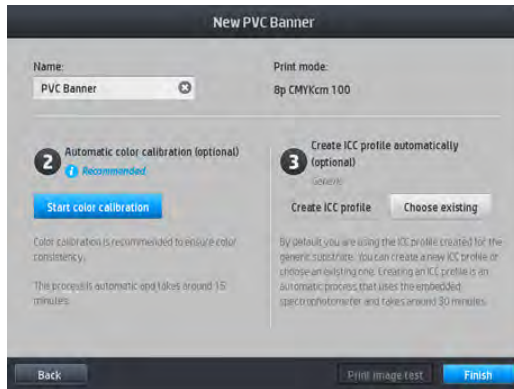

- Enter your substrate name and click **Start color calibration**. See [Color calibration on page 99](#).
- After the automatic color calibration process has completed, we recommend using the generic ICC profile; alternatively, you can choose to create a new profile or to copy a profile already assigned to a different print mode for this substrate (if there are any such profiles). The **Create ICC profile** button is disabled until color calibration is complete. See [ICC profiles on page 103](#).

## Change settings while printing

You can use the front panel to adjust the following settings while printing.

- To change temperature, vacuum, inter-pass delay offset, and substrate-advance settings while printing, press **Adjustments** in the front panel's print job screen, and choose the setting that you want to adjust. The changes that you make take effect immediately, but they are not saved: the next job will use the settings in the substrate preset as usual.

You can use the **Save** button to save settings, and the **Reset** button to restore the last saved settings.

 **NOTE:** The **Save** button is not available for a generic or non-editable preset.



- To change substrate advance calibration while printing (in case of banding): press **Adjustments** > **Adjust substrate advance**. The changes that you make take effect immediately, but they are not saved for the next job. See also [Substrate advance adjustment while printing on page 114](#).

To make permanent substrate-advance changes, use the RIP or front panel to modify the substrate preset.

## Temperature profile

Many of the main and advanced substrate settings are related to temperature control, since this is a critical area for correct printing results with latex inks on a wide variety of substrates.

 **NOTE:** There is a delay between making a change and seeing the results. See the front panel for actual temperature checking.

 **NOTE:** If you selected English units of measurement, you may notice some discrepancies, as the printer works in Celsius and makes the conversion.

## Select the number of passes

Increasing the number of passes will tend to improve the print quality but reduce the speed of printing.

 **NOTE:** The following table is for the normal ink limit unless otherwise indicated.

Category	Substrate name	Available print modes		
Banner	Generic PVC Banner	4p_4C_80	6p_6C_100	10p_6C_110
	Generic Backlit PVC Banner	12p_6C_200	16p_6C_200	20p_6C_200
Self-adhesive vinyl	Generic Self-Adhesive Vinyl	6p_4C_80	8p_6C_100	10p_6C_110
	Generic Backlit Self-Adhesive Vinyl	12p_6C_130	16p_6C_150	20p_6C_200
Paper	Generic Paper	6p_4C_80	8p_6C_100	10p_6C_110
	Generic Coated Paper	8p_6C_90	10p_6C_100	
	Generic Backlit Paper	12p_6C_130	16p_6C_150	20p_6C_150
PP & PE film & banner	Generic PP & PE Synthetics	12p_6C_80	16p_6C_80	20p_6C_90
	Generic Backlit PP & PE Synthetics	12p_6C_130	16p_6C_130	20p_6C_150
PET film	Generic Polyester Film	6p_4C_80	8p_6C_100	10p_6C_110
	Generic Backlit Polyester Film	12p_6C_170	16p_6C_185	20p_6C_200
Textile	Generic Textile	12p_6C_200	16p_6C_200	20p_6C_230
	Generic Canvas & Coated Textile	10p_6C_110	12p_6C_110	

### Key

- **XXp:** Number of passes
- **XXC:** Number of colors
- **XXX:** Ink density

 **NOTE:** More specific settings for many substrates from different vendors are available in the HP Substrate Finder at <http://www.hp.com/go/latexmediafinder/>.

 **NOTE:** After selecting the number of passes in the Add New Print Mode screen, make sure to reset your print mode to default category values for that print mode.

## Tips

- 2 to 4 passes provide lower print quality. Also, the color gamut will be slightly reduced, as total ink is limited to allow for curing.
- 1200 dpi print resolution is available in the 18-pass print mode only. If you intend to use it, ensure that you have a specific substrate preset for this print mode, because reusing others may not deliver the expected print quality.
- For fast layout proofing on low-cost substrates, a low-ink 2-pass print mode has been enabled. It is recommended for paper-based substrates only, as curing may not work correctly for other substrate types in this mode.

## Delete a substrate preset

You can delete substrate presets that you have added yourself, but not those that were supplied with the printer.

To do so, just press the  icon in the Substrate Library screen.

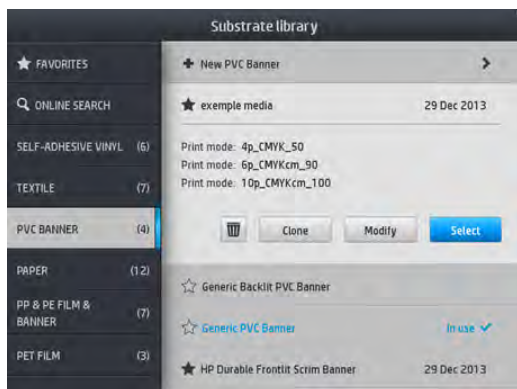

If you delete a preset, you will lose the reference to that substrate in the usage and accounting information. Instead of the name of the substrate, from that moment on you will see “Deleted substrate” in the usage and accounting information.

## Faster printing

The obvious way to increase speed is to reduce the number of print passes, although this will tend to reduce print quality. Bear in mind the following considerations.

- With fewer than 8 passes, you may see an increase in grain.
- With fewer than 6 passes, the printer is more sensitive to substrate-advance problems, and you may need to reduce the ink quantity to improve print quality.
- As you reduce the number of passes, the best curing temperature may be more difficult to find, and may be more sensitive to the ambient temperature and humidity.

Here are some other suggestions for increasing the speed of printing.

- Concatenating prints saves time, because one can be printed while another is being cured.
- Disable the cutter from the RIP software, or press , then **Substrate handling options > Cutter > Off**.

With most substrates, this saves some time at the end of the printing process. Remember to re-enable the cutter later.



**NOTE:** Printing a single job for more than 2 hours can reduce the life of the printheads.



See also [Printer seems slow on page 164](#).

## Color calibration

The purpose of color calibration is to produce consistent colors with the specific printheads, inks, and substrate that you are using, and in your particular environmental conditions. After color calibration, you can expect to get very similar prints from your printer on different occasions.

Each substrate must be calibrated independently.

---

 **NOTE:** Color calibration may not work correctly with non-HP ink.

---

There are cases in which a substrate may not be calibrated, in which cases the **Calibrate** and **Reset** options are not available:

- The loaded substrate has a generic preset.
- The loaded substrate has a preset that is not editable.
- The loaded substrate is not suitable for color calibration.

Color calibration can be launched from the front panel, after pressing **Modify preset**, or when adding a new substrate.

In outline, the process consists of the following steps.

1. A calibration target is printed.
2. The colors on the calibration target are measured automatically.
3. The calibration target measurements are compared with an internal reference to calculate the necessary calibration tables for consistent color printing on the substrate in use.

Factory default calibration tables are used whenever color calibration has never been run. The first time color calibration is run, the current printing color is taken as a reference, and factory default calibration tables continue to be used. This means that, after the first color calibration, the printed colors do not change, but are recorded as the reference for future calibrations. Subsequent color calibrations compare calibration target colors with the recorded reference, in order to calculate new calibration tables for consistent color printing on that particular substrate type.

From the front panel, you can delete the current calibration table, leaving the factory default calibration table active, as if that particular substrate had never been calibrated. Press , then **Image quality maintenance > Color calibration > Reset to factory**.

Color calibration as described above is not recommended for the following substrate types. It may be possible to calibrate some of these substrates by using an external color measurement device, driven by an external RIP.

- Non-opaque substrates such as clear film and backlit substrates.
- Substrates with an uneven surface, such as perforated vinyl and punched-window substrates.
- Porous substrates that require the use of the ink collector.

Substrates suitable for color calibration include even-surfaced adhesive vinyls (neither punched nor perforated), PVC banners, and papers.

Some substrates require the take-up reel for successful printing. However, the take-up reel may fail to cope with the backward movement of the substrate between the printing and scanning phases of color calibration. To perform color calibration when the take-up reel is in use, proceed as follows:

1. Ensure that the take-up reel is enabled. At the front panel, press , then **Enable take-up reel**.
2. Set the take-up reel's winding direction to the off position. See [Unload the take-up reel on page 76](#).
3. Manually rewind the take-up reel, using the buttons on the take-up reel motor, to collect the substrate and raise the tension bar until it almost touches the take-up reel.
4. Launch color calibration from the front panel.
5. When the color calibration has finished, you can reset the take-up reel's winding direction.

## Color calibration for the 315 or 335 printer

The color calibration test chart is printed using a fixed print mode with a high number of passes and fixed curing and drying settings to ensure printing consistency. However, parameters affecting substrate advance should be fine-tuned, and printheads should be aligned, before starting color calibration for the first time.

To start color calibration of the loaded substrate from the front panel, select , then **Image quality maintenance > Color calibration > Calibrate**. Color calibration can also be run while adding a new substrate (see [Add a new substrate on page 94](#)).

---

 **NOTE:** Only substrates at least 61 cm (24 in) wide can be calibrated.

---

The calibration process is fully automatic and can be performed unattended after you have loaded substrate of the type you wish to calibrate. The process takes about 15 minutes and consists of the following steps:

1. The color calibration test chart is printed, which contains patches of different densities of each ink used in your printer.

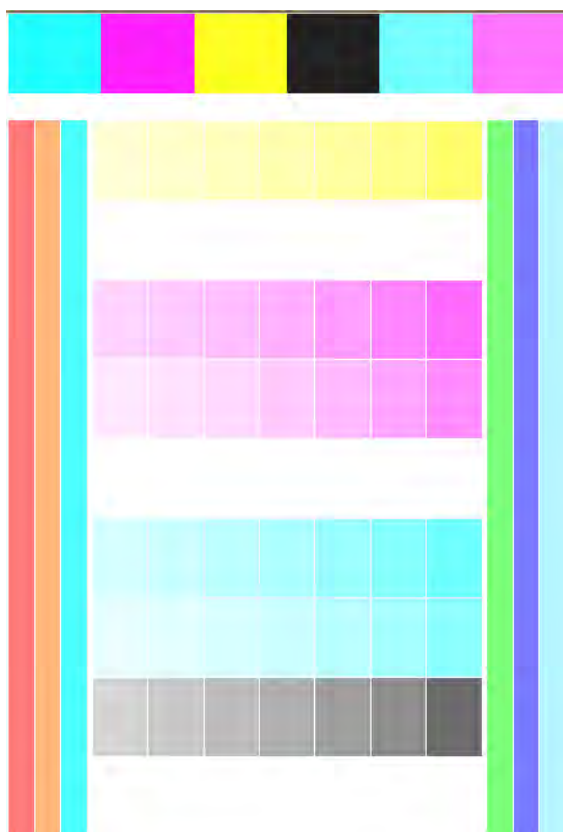

2. The test chart is scanned by the line sensor. If the scan cannot be completed successfully, a message is displayed on the front panel; see [Front-panel error codes on page 166](#).
3. From the measurements made by the line sensor, the printer calculates the necessary correction tables to apply to your print jobs, for consistent color printing on that substrate type.

Calibration should be done in any of the following circumstances:

- Whenever a new substrate type is introduced that has not yet been calibrated.
- Whenever you notice excessive color differences between prints. Such color differences are mainly caused by aging and wear of the printheads, installing new printheads, and changes in substrate characteristics between one roll and another.

You can check the color calibration status of your substrate by pressing  on the front panel.

- **Recommended** status indicates that this substrate has never been calibrated. In this case, the factory-default color tables will be applied to print jobs, as there is no reference state defined. After one or more color calibrations have been performed, pressing the **Reset** button returns the status to Recommended.
- **Done** status indicates that a color calibration has been performed successfully at least once on this substrate, and therefore a color reference state is defined.
- **Obsolete** status indicates that the last color calibration may be out of date. For instance, color calibration status is set to Obsolete whenever a printhead is replaced. The color reference state remains defined.
- **N/A** indicates that this substrate cannot be color-calibrated.

---

 **NOTE:** Generic substrates cannot be color-calibrated, although such substrates may be suitable for color calibration. You can color-calibrate clones of most generic substrates.

---

 **TIP:** If color calibration fails, it is worth trying again.

**TIP:** If the first color calibration of a new substrate fails, press the **Reset** button before trying again.

## Color calibration for the 365 or 375 printer

The color calibration test chart is printed using a fixed print mode with a high number of passes and fixed curing and drying settings to ensure printing consistency. However, parameters affecting substrate advance should be fine-tuned, and printheads should be aligned, before starting color calibration for the first time.

To start color calibration of the loaded substrate from the front panel, select , then **Image quality maintenance** > **Color calibration** > **Calibrate**. Color calibration can also be run while adding a new substrate (see [Add a new substrate on page 94](#)).

 **NOTE:** Only substrates at least 61 cm (24 in) wide can be calibrated.

The calibration process is fully automatic and can be performed unattended after you have loaded substrate of the type you wish to calibrate. The process takes about 15 minutes and consists of the following steps:

1. The color calibration test chart is printed, which contains patches of different densities of each ink used in your printer.

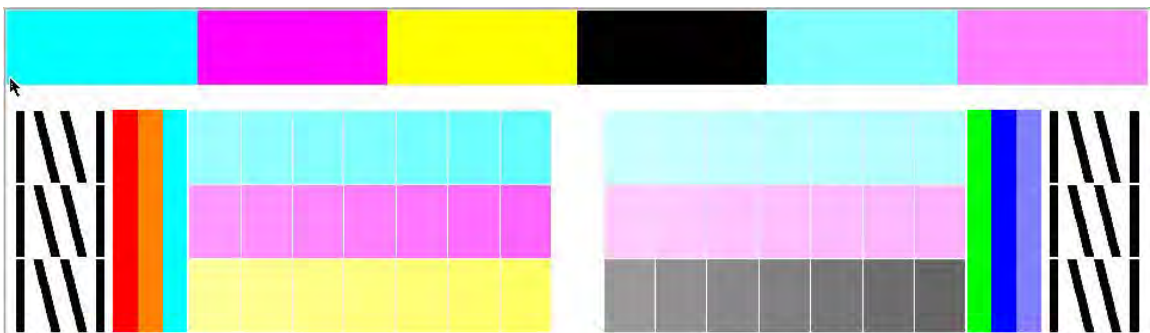

2. The test chart is scanned by the HP Embedded Spectrophotometer. If the scan cannot be completed successfully, a message is displayed on the front panel; see [Front-panel error codes on page 166](#).
3. From the measurements made by the spectrophotometer, the printer calculates the necessary correction tables to apply to your print jobs, for consistent color printing on that substrate type.

Calibration should be done in any of the following circumstances:

- Whenever a new substrate type is introduced that has not yet been calibrated.
- Whenever you notice excessive color differences between prints. Such color differences are mainly caused by aging and wear of the printheads, installing new printheads, and changes in substrate characteristics between one roll and another.

You can check the color calibration status of your substrate by pressing  on the front panel.

- **Recommended** status indicates that this substrate has never been calibrated. In this case, the factory-default color tables will be applied to print jobs, as there is no reference state defined. After one or more color calibrations have been performed, pressing the **Reset** button returns the status to Recommended.
- **Done** status indicates that a color calibration has been performed successfully at least once on this substrate, and therefore a color reference state is defined.
- **Obsolete** status indicates that the last color calibration may be out of date. For instance, color calibration status is set to Obsolete whenever a printhead is replaced. The color reference state remains defined.
- **N/A** indicates that this substrate cannot be color-calibrated.

---

 **NOTE:** Generic substrates cannot be color-calibrated, although such substrates may be suitable for color calibration. You can color-calibrate clones of most generic substrates.

---

 **TIP:** If color calibration fails, it is worth trying again.

**TIP:** If the first color calibration of a new substrate fails, press the **Reset** button before trying again.

---

## Color consistency between different printers (365, 375)



It is possible to cross-calibrate color between two or more printers for particular substrates. After cross-calibrating a given substrate, you can expect to get very similar prints from either printer when using the same substrate.

1. Choose printer A to be the reference printer, and use it to perform color calibration on the substrate in question. See [Color calibration on page 99](#).
2. Export the calibrated substrate preset. See [HP Media Locator on page 91](#).
3. Import the substrate preset of step 2 into printer B. See [HP Media Locator on page 91](#).
4. Color-calibrate the preset with printer B.
5. Colors printed with printer A and printer B, on that substrate, should now be very similar.
6. To add more printers (C, D, and so on), proceed as you did with printer B.

## ICC profiles

Color calibration provides consistent colors, but consistent colors are not necessarily accurate. For instance, if your printer prints all colors as black, its colors may be consistent but they are not accurate.

In order to print accurate colors, it is necessary to convert the color values in your files to the color values that will produce the correct colors from your printer, your inks, your print mode, and your substrate. An ICC profile is a description of a printer, ink, print mode, and substrate combination that contains all the information needed for these color conversions.

These color conversions may be performed by your Raster Image Processor (RIP), if it offers that possibility; they are not performed by the printer. For further information on the use of ICC profiles, see the documentation for your application software and for your RIP.

In addition to the ICC profiles used for printing, you may wish to calibrate and profile your monitor (display device), so that the colors you see on the screen relate more closely to those that you see on your prints.

## Generating color profiles with the 365 or 375 printer

It is possible to create an ICC profile automatically for a given substrate and print mode, when adding or editing a substrate. See [Add a new substrate on page 94](#) and [Modify a substrate preset on page 93](#).

After pressing the **Create ICC profile** button the following process takes place:

1. A profiling test chart is printed on the loaded substrate using the selected print mode.
2. The printed test chart is measured with the HP Embedded Spectrophotometer.
3. The color measurements are related to the target colorant values by the printer's firmware to generate the ICC profile.
4. The ICC profile is stored in the substrate preset for that print mode.

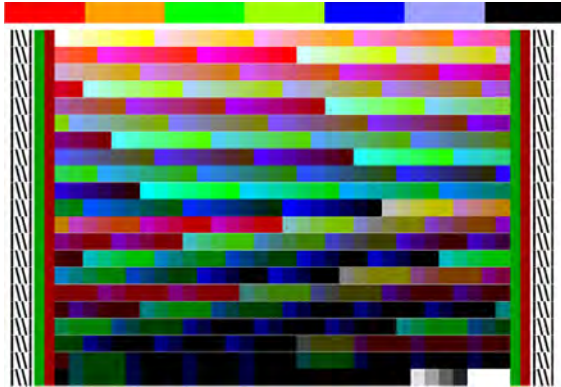

**NOTE:** Although color profiles obtained in one particular print mode can be reused when printing with other print modes, the most accurate color reproduction can only be achieved if profiling is made with exactly the same print mode that is used for printing. For example, if you use a color profile obtained with a 12-pass standard print mode, you may see some color difference when you use it to print with an 8-pass speed print mode.

**TIP:** To test the just-created ICC profile on the internal test image, press the **Print Test Image** button.

The following image is printed with the just-created ICC profile applied to it.

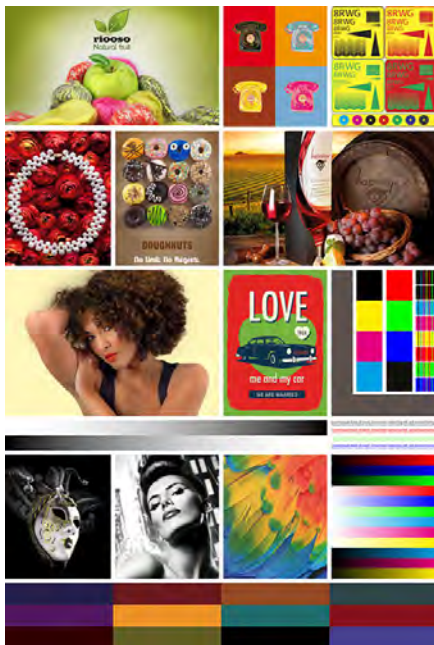

## Improve color consistency when tiling

The easiest way for to improve color consistency when tiling is by using an optimize for tiling substrate.

**NOTE:** To achieve the best color consistency, all optimized for tiling substrates have a 1 second inter-swath delay default. This can be changed, but consistency can not then be assured.

1. In the substrate library, select the substrate family to optimize for tiling.

 **NOTE:** This option is only available for substrate families that can support it (SAV, Banner and WallPaper).

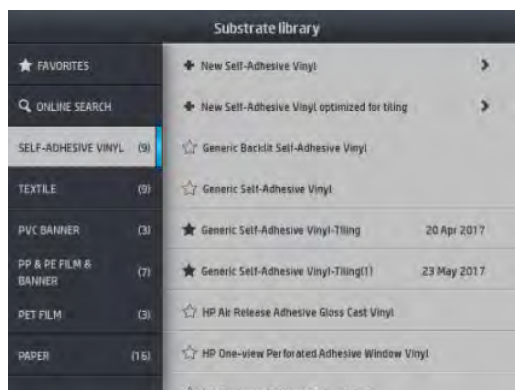

2. Select the **new family substrate optimized for tiling**.
3. Select the substrate with the closest properties as a base.

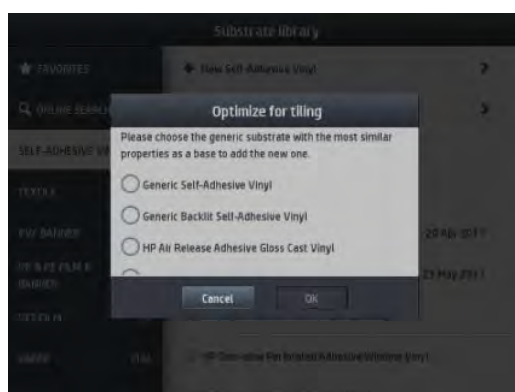

4. Select the print mode to create the ICC profile.

 **NOTE:** The number of passes cannot be lower than 8, only profiles higher than 8 will appear. If none of your profiles has 8 or higher, a default appears.

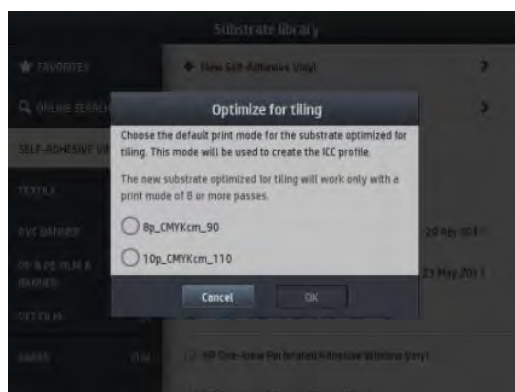

5. Set the color reference and create the ICC profile.

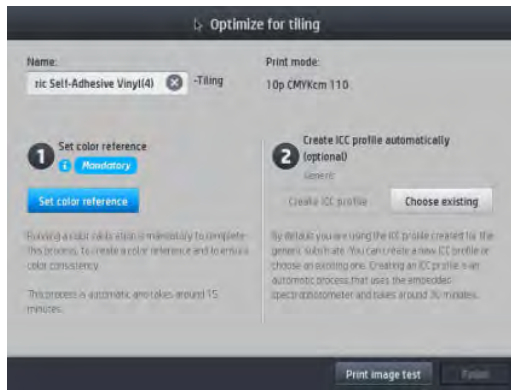

---

 **IMPORTANT:** Color calibration is mandatory for this kind of print mode.

 **NOTE:** A Tiling suffix is added to the name of the substrate, you edit the name, but cannot erase the suffix.

---

6. Substrate can be exported from one printer to another. For using the imported profile, we recommend you run a color calibration in the new printer.

---

 **IMPORTANT:** Tiling substrates may not import with old firmware.

---



---

## 5 Troubleshoot print-quality issues

- [General printing advice](#)
- [Quick Solutions application \(365 and 375 only\)](#)
- [Improve print quality](#)
- [Most-common print-quality problems](#)

## General printing advice



Use the following approach when you have any print-quality problem:

- Make sure that the substrate type that you select on the front panel, and in your RIP software, is the same as the substrate type that is loaded in the printer. Make sure that the substrate type has been calibrated (including substrate-advance, printhead, and color calibration).

---

**⚠ CAUTION:** If you have the wrong substrate type selected, you could experience poor print quality and incorrect colors, and perhaps even damage to the printheads.

---

- Make sure that you are using the correct substrate preset for your substrate, with the correct ICC profile, or that you have followed the correct procedure to generate a new substrate preset (see [Add a new substrate on page 94](#)).
- Make sure that you are using appropriate print-quality settings in your RIP software.
- Make sure that your environmental conditions (temperature, humidity) are in the recommended range. See [Environmental specifications on page 175](#).
- Make sure that your ink cartridges have not passed their expiration dates. See [Maintain the ink cartridges on page 129](#).
- Avoid touching the substrate while printing is in progress.
- Trying to print jobs with a lot of ink in fast modes (commonly 6 passes or below) may result in not-completely-dry output and/or other print-quality problems. Consider using modes with higher passes when printing with a lot of ink, or increase the curing temperature. Note that increasing the curing temperature may deform your substrate (see [Substrate is deformed or wrinkled on page 84](#)).

## Quick Solutions application (365 and 375 only)

The Quick Solutions application can help you to adjust the printer when it is not performing as expected.

You can start the application by pressing  on the front panel.

The application has four sections with different purposes:

- **Generic solutions:** This section has generic solutions to readjust the printer. Each generic solution is a set of actions launched all in one.
- **Test plots:** All available test plots can be run from this section.
- **Maintenance routines:** Maintenance routines for various printer assets are available in this section.
- **Image problems:** This section contains potential image problems that can be seen when the printer is wrongly adjusted. For each problem, there is a list of possible actions that can help to solve the problem. The actions are in order of likely effectiveness.

## Improve print quality



### Improve print quality (315, 335)

As a first step, you may be able to improve print quality with a single command. At the front panel, press , then **Image-quality maintenance** > **Optimize print quality**.

This performs printhead recovery, alignment, and color calibration routines, in order to optimize your print quality automatically in a single step. Allow up to 30 minutes for the printer to perform the whole process.

If you still experience print-quality problems, you can follow a more hands-on print-quality troubleshooting procedure, by printing, interpreting, and performing corrective actions.

You can print all the test plots at once for complete debugging of your print-quality problem. At the front panel, press , then **Image-quality maintenance** > **Print all test plots**.

Alternatively, you can print the test plots individually for specific debugging of nozzle health, alignment, optimizer, or substrate-advance print-quality issues as described below.

### Improve print quality (365, 375)

As a first step, you may be able to improve print quality with a single command. At the front panel, press .

You will see the option **Optimize print quality**. This performs printhead recovery, alignment, and color-calibration routines, in order to optimize your print quality automatically in a single step. Allow up to 30 minutes for the printer to perform the whole process.

In the same quick solutions application, in the section **Generic solutions**, you can **Print all test plots** at once for complete debugging of your print-quality problem. Alternatively, in the **Test plots** section, you can print the test plots individually for specific attention to nozzle health, alignment, or substrate-advance issues (see later in this chapter). Also explore the sections **Maintenance routines** and **Image problems**.

If you still experience print-quality problems, you can follow a more hands-on print-quality troubleshooting procedure, by printing, interpreting, and performing corrective actions.

## 1. Printhead status plot

The printhead status plot consists of patterns that are designed to highlight printhead reliability problems. It helps to determine whether any printhead is experiencing clogging or other problems.

To print this plot, go to the front panel and press , then **Image-quality maintenance** > **Clean printheads** > **Print test plot**. Vinyl, preferably gloss at least 36 inches wide, is recommended for maximum visibility. Other substrate types may not show enough detail to see the optimizer dashes clearly.

The plot consists of small dashes, one for each nozzle on each printhead.

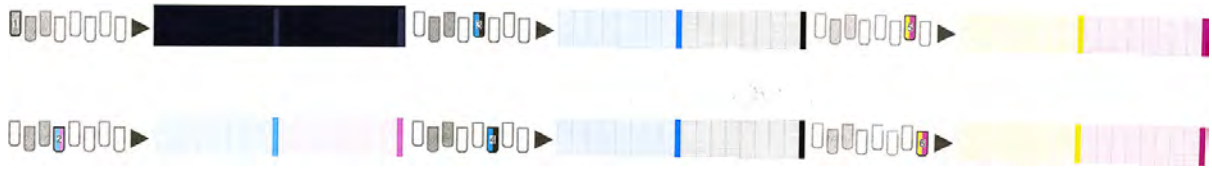

For each individual colored pattern, make sure that most of the dashes are present.

### Corrective action

1. Clean any faulty printheads. See [Clean \(recover\) the printheads on page 133](#). Then reprint the printhead status plot to see whether the problem has been solved.
2. If the problem persists, clean the printheads again, and reprint the printhead status plot to see whether the problem has been solved.
3. If the problem continues to persist, replace any persistently faulty printheads. See [Replace a printhead on page 136](#).

## 2. Optimizer check plot

To print the optimizer check plot:

1. Use the same substrate type that you were using when you detected a problem.
2. Check that the selected substrate type is the same as the substrate type that is loaded into the printer.
3. Go to the front panel and press , then **Image-quality maintenance > Print latex optimizer test plot**.

The latex optimizer is a transparent fluid that may not be visible on all substrates; vinyl is recommended for maximum visibility. This print consists of several area fills, text, lines and color bars. It is intended to identify print-quality problems that may be caused by optimizer nozzle defects.

### LATEX OPTIMIZER PERFORMANCE PRINTING 10 PASSES BIDIRECTIONAL

**SIMULATED PERFORMANCE INCREASING OPTIMIZER LEVEL**

**SIMULATED PERFORMANCE FORCING UNHEALTHY OPTIMIZER**

**YOUR CURRENT PERFORMANCE**

a) Compare current performance (=) with simulated situations (-) and (+)  
 b) Check for optimizer alerts in front panel  
 c) Refer to the user guide if further assistance is needed

Compare the three rows.

- The row with the **+** symbol shows a simulated image with an above-normal amount of optimizer.
- The row with the **-** symbol shows a simulated image with a below-normal amount of optimizer, equivalent to more than 200 blocked nozzles.
- The row with the rectangle around it and the **▬** symbol shows the current performance of the printer, printing 10 passes.

Look for differences in performance between the images, such as bleeding in the color bars, graininess in the area fills, blurred text, and overall print quality.

If there is little difference in quality between the rows, there are at least two possible explanations:

- The substrate is not sensitive to the amount of optimizer. There is probably no problem with the optimizer printhead. Consider other explanations for whatever problem you have.
- There may be a problem with the optimizer printhead if you see high levels of coalescence and bleed as in the bad  examples below. In this case, try to clean the optimizer printhead; see [Clean \(recover\) the printheads on page 133](#).

---

 **NOTE:** The front panel shows an advisory message if abnormal optimizer performance has been detected.

---

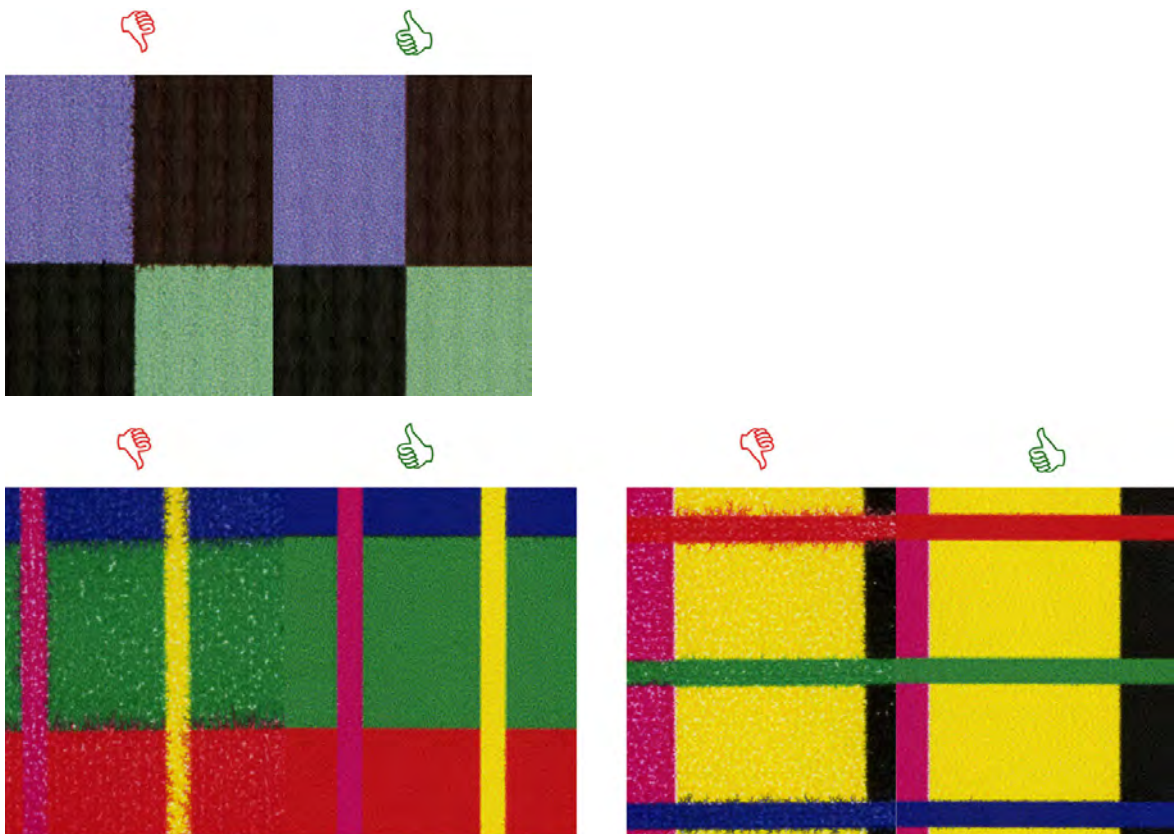

## Bleed Bad vs Good samples

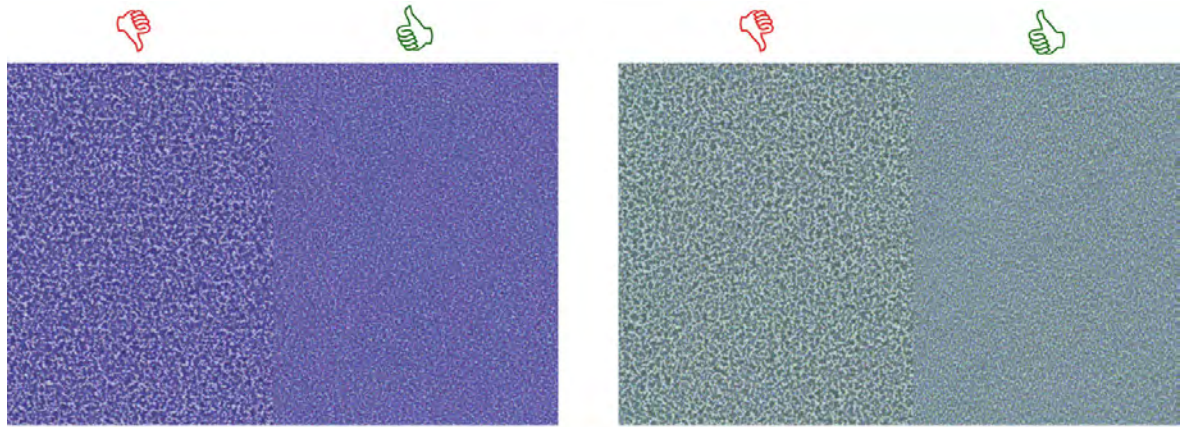

## Coalescence Bad vs Good samples

If there is a clear difference in quality between the rows, there are at least two possible explanations:

- If the quality of the row with the **+** symbol is higher, the substrate is very sensitive to the amount of optimizer. Go to your substrate library on the front panel or in your RIP, select your print mode, and increase the amount of optimizer in the advanced settings. See [Add a new substrate on page 94](#).
- If you see no difference in quality between the rows with the **+** and **+** symbols, but the row with the **+** symbol looks worse, the substrate is sensitive to the amount of optimizer, but there seems to be no problem with the optimizer printhead or the amount of optimizer used. Consider other explanations for whatever problem you have.

### 3. Printhead alignment status plot

To print the printhead alignment status plot:

1. Use the same substrate type that you were using when you detected a problem. Or consider using vinyl gloss substrate for better visibility of the optimizer in particular.
2. Go to the front panel and press , then **Image-quality maintenance > Align printheads > Print test plot**.



Check the continuity of the thin diagnostic lines on the alignment status plot. In one section, colored lines are printed in line with black lines to test the alignment from one color to another. In another section, colored lines are printed such that one half is made with a forward pass and one half is made with a reverse pass to test the alignment between the two directions. In both sets of patterns, printhead misalignment will be visible as a step in the line at its center (marked with a short black line).

### Printhead Alignment Status Plot

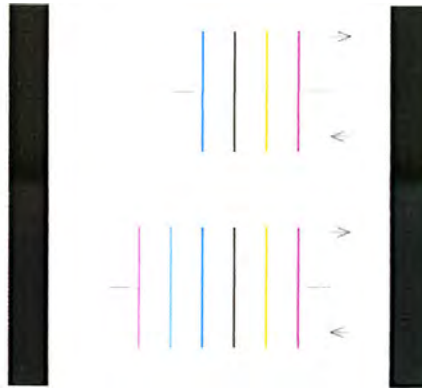
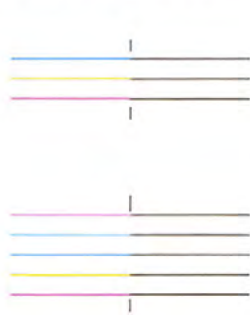

Bear in mind that small misalignments may not cause any print-quality defects. The printing process is designed to hide the effects of small amounts of misalignment. The reference scale can be used to quantify the amount of misalignment; errors below 4/600 inch are unlikely to cause print-quality defects.

The optimizer fluid is transparent and cannot usually be seen directly. The fluid can be seen on some substrates (such as self-adhesive vinyl) when printed in conjunction with the colored inks. The cross pattern that is printed above the reference scale is printed in this way and can be used to evaluate the alignment of the optimizer on some substrates. In a well-aligned system, the light-colored cross at the center of the pattern will be aligned with the four black lines at the sides of the pattern. The following figure shows how this pattern will appear on the substrates on which it is visible. This sample is slightly misaligned.

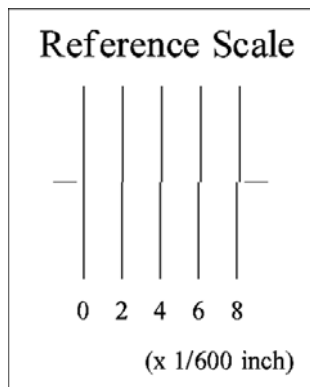
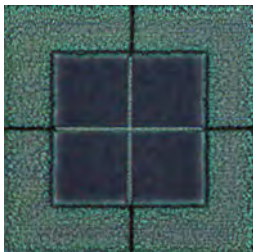

If the printheads are misaligned or you feel unsure about them—for example, because a substrate crash occurred—then align the printheads. See [Align the printheads on page 134](#).

## 4. Substrate-advance check plot

To fine-tune the quality of your print, you may need to adjust the rate at which the substrate advances. The substrate advance determines the placement of dots on the substrate. If the substrate is not advanced correctly, light or dark bands appear in the printed image and the grain in the print may increase.

You can modify the substrate advance from the RIP or front panel with the Substrate Advance parameter in the substrate preset.

To print the substrate-advance check plot:

1. Use the same substrate type that you were using when you detected a problem.
2. Check that the selected substrate type is the same as the substrate type that is loaded into the printer.
3. Go to the front panel and press , then **Image-quality maintenance > Substrate advance calib > Print adjustment plot**.

The substrate-advance check plot consists of several columns with a number at the bottom of each one. Locate the lightest of the columns and enter its number into the Substrate Advance parameter for the current substrate preset. The value chosen in this example should be “-6”.

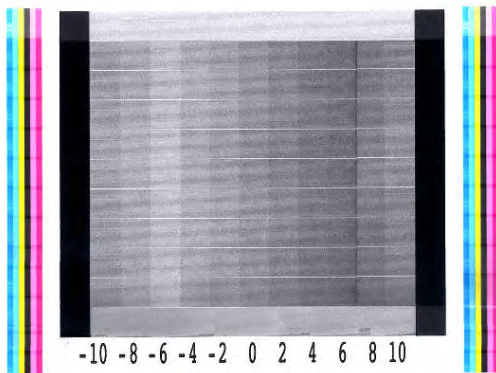

 **NOTE:** Minor substrate-advance problems ( $\pm 2$  around the 0 value) are unlikely to result in any print-quality problem, especially with print modes of more than 8 passes.

## Substrate advance adjustment while printing

If you are using no more than six passes, you can fine-tune the substrate advance while printing: press 

then **Adjustments > Adjust substrate advance**. Select a value of change from -10 mm/m to +10 mm/m (or mils/inch). To correct light banding, decrease the value. To correct dark banding, increase the value.

If you are using eight passes or more, a wrong advance adjustment will not produce banding but graininess, which is harder to assess visually. Therefore, in this case you are recommended to use only the adjustment plot.

When you have chosen a value and pressed **OK**, the rest of your job will be printed with that value, but it will be reset to zero at the end of the job. Add the value found to the Substrate Advance value in the preset to print all future jobs with the new setting.

## What to do if problems persist

If you still experience print-quality problems after applying the advice in this chapter, here are some additional tips to consider:

- Try selecting a higher print-quality option in your RIP software, by increasing the number of passes.
- Check that your printer firmware is up to date. See [Firmware update on page 157](#).
- Check that you have the correct settings in your software program.
- Call your service representative. See [When you need help on page 38](#).



# Most-common print-quality problems

## Graininess



If you see this kind of problem:

- Ensure that the vertical correction option is disabled in the RIP and in the front panel. At the front panel, press , then **Image-quality maintenance** > **Vertical correction** (if this option is available).
- The printheads may be misaligned. This is likely if you have not aligned the printheads for a long time, or if there has been a substrate jam. Align the printheads if necessary (see [Align the printheads on page 134](#)). You can check whether it is necessary by using the printhead alignment status plot (see [3. Printhead alignment status plot on page 112](#)).
- The substrate-advance sensor may be dirty. This can happen when printing on porous substrates with the 365 or 375 printer, even when using the ink collector (see [Clean the substrate-advance sensor window on page 154](#)).
- If you are printing with eight or more passes, the substrate advance may need fine adjustment. See [4. Substrate-advance check plot on page 113](#).
- Use a higher number of passes: you will probably see less grain with ten or more passes.
- If graininess is more visible in light area fills, with the appearance of coalescence graininess (see [2. Optimizer check plot on page 110](#)), try the following solutions:
  - Go to your substrate library on the front panel or in your RIP. Select your print mode and increase the amount of optimizer in the advanced settings. See [Add a new substrate on page 94](#).
  - Clean the optimizer printhead.
  - Print in Economode (four colours).



**NOTE:** A small change in overall graininess (but not coalescence) may be perceived in some areas because the light-colored inks, which are not used in Economode, help to provide smooth transitions.

## Horizontal banding

Try the following remedies if your printed image suffers from added horizontal lines as shown (the color may vary).



- If you are using a print mode with six or fewer passes, try increasing the number of passes. Some degree of banding can be expected with few passes.
- If bands affect all colors across the width of the printed image, the cause is probably a substrate advance problem. Use the front panel to adjust the substrate advance on the fly (see [Substrate advance adjustment while printing on page 114](#)). If you have dark bands, increase the substrate advance; if you have light bands, decrease it. When you find the right adjustment, store the value in the front panel for future prints on the same substrate.

Another cause could be a fiber attached to one of the printheads. Turn off the printer, then remove the printheads one at a time and remove any fibers that you see attached to them.

- If bands affect only some colors, the cause could be a defective printhead.
  - Print the printhead status plot (see [1. Printhead status plot on page 109](#)). If necessary, clean the printheads (see [Clean \(recover\) the printheads on page 133](#)).
  - Sometimes a single cleaning action may not completely clean every nozzle. Print the status plot and consider cleaning again.
  - Align the printheads (see [Align the printheads on page 134](#)). If necessary, align them manually.
  - Print the printhead status plot again. Identify the printhead with the greatest number of blocked nozzles, and replace it.

---

 **NOTE:** The optimizer printhead is unlikely to cause this kind of problem.

---

- If bands affect most of the colors, the printheads could be misaligned. This is likely if you have not aligned the printheads for a long time, or if there has been a substrate jam. Align the printheads if necessary (see [Align the printheads on page 134](#)). You can check whether it is necessary by printing the printhead alignment status plot (see [3. Printhead alignment status plot on page 112](#)).
- If banding occurs mostly in black areas, create a new color profile using pure black and not a mixture of other colors. See your RIP documentation.
- Due to the printhead servicing routines while printing, some fibers or small amounts of ink may be deposited on a nozzle, causing it to fail temporarily. This is very unlikely and may just cause a couple of isolated bands. It is also very unlikely for this to be repeated within the same or subsequent print jobs. However, if you notice it, try cleaning the printheads (see [Clean \(recover\) the printheads on page 133](#)).

If the problem persists, call your service representative (see [When you need help on page 38](#)).

## Vertical banding

Different kinds of vertical bands may appear, for different reasons.

- Regular vertical bands matching the shape of the platen may be seen on paper-based substrates and in general on thin substrates in medium-density area fills such as grays or violets. Try the following suggestions to mitigate this problem:

- Align the printheads. See [Align the printheads on page 134](#).
- Reduce the vacuum level in steps of 5 mmH<sub>2</sub>O when printing on vinyl. Do not exceed the lower limit of 10 mmH<sub>2</sub>O for vinyls or 25 mmH<sub>2</sub>O for papers to avoid crashes and/or smears.
- Irregular or isolated vertical bands with abnormal levels of graininess
  - Increase the vacuum level in steps of 5 mmH<sub>2</sub>O. Do not exceed the following limits: 20 mmH<sub>2</sub>O for banners, 45 mmH<sub>2</sub>O for vinyl, and 50 mmH<sub>2</sub>O for other substrate families.
  - In backlit applications, increase the number of passes to 20, maintaining the vacuum level below 20 mmH<sub>2</sub>O.
  - If the banding appears only at the beginning of the print, disable the cutter (365 and 375 only) and advance the substrate manually about 100–150 mm before the first print.
- A single thin vertical line may be caused by air flowing through the small gaps in between the parts that form the print platen.
  - Check that all the vertical gaps in the print zone (including the central separation between the two removable print zones) are covered with a sticker.
  - If one is found missing or damaged, you can replace it with one of the spare stickers provided in the User Maintenance Kit, or with a small piece of self-adhesive vinyl.
- Vertical banding with particular colors in high-density print modes with many passes
 

Some particular colors (usually tertiary colors) may present vertical banding when printing at very high densities and with many passes. This is due to differential ink drying in the print zone. Try the following suggestions to fix the problem:

  - Reduce the number of passes: Fewer passes mean faster printing, so the ink arrives more uniformly fresh in the curing area.
  - Reduce the ink density: Lower ink density gives more uniform drying in the print zone.
  - Reduce the optimizer level: Reducing the optimizer level means that the ink arrives fresher in the curing area (the required level varies according to the substrate, but a suggested starting point is 6) . Colors may change slightly after changing the optimizer level. You may want to perform a color calibration to fix the color shift.

## Print is deformed into a curved shape

This may occur as a result of substrate bow deformation. See [Substrate has bow deformation on page 85](#).

## Misaligned colors



If the colors are misaligned in any direction, the printheads may be misaligned. This is likely if you have not aligned the printheads for a long time, or if there has been a substrate jam. Align the printheads if necessary (see

[Align the printheads on page 134](#)). You can check whether it is necessary by printing the printhead alignment status plot (see [3. Printhead alignment status plot on page 112](#)).

## Color variation and text-line correction

If some printhead nozzles are in use while others in the same printhead are not, water evaporates slowly from the ink in the unused nozzles, making the color more intense. Thus, in such cases you may notice variations in color intensity in areas where the color of the image should be constant.



If you notice such a problem, there are various possible solutions.

1. If you notice the variation in intensity near one side of the print, try rotating the image by 180 degrees before printing. This may solve the problem in some cases, as all the nozzles are refreshed whenever they enter the service station between passes.
2. Use your RIP to add lateral color bars on the side of the plot that is close to the ink supplies. The color bars are designed to exercise all the printhead nozzles, to prevent the problem from occurring.

 **NOTE:** Not all RIPs provide this option.



3. Add lateral color bars to the image, manually, before printing. In this case, you can either use the standard colors, or decide to include a particular color in which you have noticed the problem. The recommended width of each color bar is 3 mm.
4. At the front panel, press , then **Image-quality maintenance > Color variation and text-line correction > On**.

If text, lines, or light solid areas are rough or blurred, try the following suggestions:

- The printheads may be misaligned. This is likely if you have not aligned the printheads for a long time, or if there has been a substrate jam. Print the printhead alignment status plot (see [3. Printhead alignment status plot on page 112](#)), and align the printheads if necessary (see [Align the printheads on page 134](#)).
- The optimizer printhead may have blocked nozzles. You can check this by printing the optimizer check plot (see [2. Optimizer check plot on page 110](#)).
- Water evaporates slowly from the ink in the unused nozzles, so the first drops of ink are ejected with lower velocity. This may happen, for example, in nozzles not used during a whole printed swath, causing the text or lines to be rough or blurred. You are recommended to go through steps 1 to 4 as described above.
- If a light area is close to the edge while printing on a thin substrate, ensure that the substrate is loaded with the substrate edge on a rib of the platen to avoid local blurring. Alternatively, try rotating the image so that the affected area is not at the edge of the substrate.

## Black areas look hazy

If black areas look hazy or not sufficiently black, try these suggestions.

- Increase the number of passes.
- Laminate the print.
- Substrate presets are designed to achieve consistent and reliable print quality on a broad range of substrates. However, you may want to consider investing in the color management process, using external tools and/or experts, to get specific results. The best dark colors on gloss vinyls and other substrates are normally obtained when using as much black and as little composite as possible when creating the ICC profile.

## Ink smears

Ink smears may be seen on the print for the following reasons.

- The substrate is skewed. Do not ignore the warning message that appears during the loading procedure if there is significant skew.
- The substrate is not flat in the print zone. Try the following possible solutions.
  - Increase the vacuum level in steps of 5 mmH<sub>2</sub>O.
  - Reduce the curing temperature. You will probably need to increase the number of passes in order to achieve adequate curing.
  - Check whether there are fibers on the printheads.

If the problem appears only at the sides of the print, because the edges are uneven or the substrate is curled upward at the sides, consider using the edge holders (see [Edge holders on page 65](#)).

If the problem appears only at the beginning of the print, try the following suggestions.

- Increase the top margin of your print to give more room at the leading edge. Alternatively, or additionally, increase the bottom margin to provide a non-deformed leading edge for the next print. See [Change margins on page 19](#).
- Increase the vacuum level in steps of 5 mmH<sub>2</sub>O. Do not exceed the following limits: 20 mmH<sub>2</sub>O for banners, 45 mmH<sub>2</sub>O for vinyl, and 60 mmH<sub>2</sub>O for other substrates. If the vacuum level is too high, you may see an increase in graininess due to too much friction between the rear surface of the substrate and the platen while advancing the substrate during printing; you may also see vertical bands matching the contours of the print platen.

- Increase the number of passes.
- Make sure that the substrate is stored in the same room in which the printer is located.



---

**NOTE:** Several substrates are sensitive to ambient conditions (temperature and humidity): if the ambient conditions are outside the recommended range, this may affect loading and printing.

---

## Uneven appearance in area fill

Subtle color differences may be seen in high-density area fills on some substrates if they are stored partially covered after printing. In the period immediately after printing, such substrates should be stored either totally covered or totally uncovered. It may be advisable to avoid prolonged face-to-face contact between two prints. This problem tends to disappear if the substrate is left uncovered for some time.

Alternatively, especially with vinyls and banners, some individual rolls may have a defective coating; for instance, the coating may have aged. This can cause uneven area fills in light areas. In this case, try a new roll.

## Ink is oily or smudges when touched

There are various different circumstances in which these symptoms can be seen.

- When the symptoms can be seen only at the start of the first print after the printer has been idle for some time (especially when the start of the print uses a lot of ink)

This may be just a temporary problem: try reprinting, and perhaps slightly reduce the ink limits. It may be worth adjusting the print queue so that the first job is not difficult to cure (uses a lot of ink).

- When the symptoms can be seen only in certain parts of the print that use a lot of ink

Increase the curing temperature, decrease the overall ink quantity, increase the number of passes, and/or modify the inter-path delay offset (in the RIP or front panel) to allow better drying on consecutive passes.

- When the symptoms appear after reducing the number of passes

Increase the curing temperature, decrease the overall ink quantity, and/or modify the inter-path delay offset (in the RIP or front panel) to allow better drying on consecutive passes.

- When the oily finish appears minutes or hours after printing

Store the print face-up and uncovered; the effect normally disappears after a while.



---

**NOTE:** If you decrease the overall ink quantity, you may notice less color saturation.

---

## Print dimensions are wrong

As the substrate is heated during the curing process, some substrates will shrink (and some may expand) after the image has been printed. This may be inconvenient if the print has to be framed or if several prints are to be tiled one next to the other.

See [Substrate has shrunk or expanded on page 84](#).

## Tiling issues



The most common problems when printing tiles are as follows.

- Color variation tile-to-tile

In some cases, contiguous tiles with the same background solid color may show differences in color between the right side of the first tile and the left side of the second tile. This is a common issue of inkjet printers (both thermal inkjet and piezo inkjet), where there are slight color variations as the swath advances.

To improve color consistency side-to-side and tile-to-tile, try adding color bars at the side of the print. These can be set from the RIP.

Since the biggest color differences are between the left edge and the right edge, the effect may sometimes be seen when putting two tiles together. This issue can easily be overcome by inverting alternate tiles, which has the effect of placing the right side of the first tile next to the right side of the second tile and the left side of the second tile next to the left side of the third, so all contiguous areas have been printed in the same point of the swath and, hence, have the same color. This is a feature that all RIPs have available.

- Dimensional variations from tile to tile

See [Variable Front Tension Kit on page 121](#).

- In bidirectional printing, minor differences in tone may be noticed on close inspection

This happens because the drying times are not the same across the scan axis. Adding a small inter-path delay offset of about 0.5–1 second may give better results.

## Variable Front Tension Kit

Depending on the loaded substrate, length inconsistency may be observed when comparing left- and right-side measurements in tiling applications using the take-up reel: measurements on the left being more inconsistent than on the right. This behavior is due to the front tension applied by the tension bar.

The Variable Front Tension Kit contains a pair of counterweights that you can attach to the arms of the tension bar, thus reducing the front tension and improving length consistency in tiling applications when printing with certain substrates (such as self-adhesive vinyl and wallpapers). Other applications and substrates, such as textiles and banners, will work better without these counterweights, therefore HP strongly recommends uninstalling the Variable Front Tension Kit when it is not needed.

The Variable Front Tension Kit can be used with both 54- and 64-inch printers, but with different adjustments.

## Installation

The Variable Front Tension Kit consists of left and right arms, two weights, two M10×180mm screws, six M10 nuts, and four washers.

Each arm and each counterweight weighs 1.4 kg.

1. Remove the weights from the right and left subassemblies.

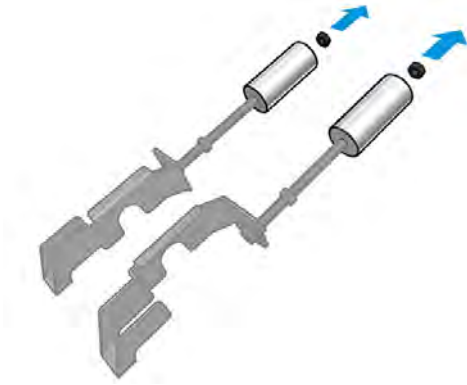

2. Remove the tension bar.

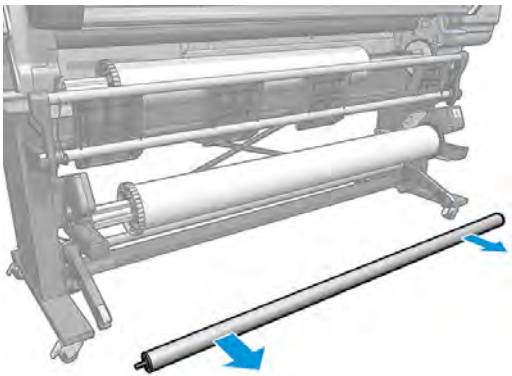

3. Remove the take-up reel to facilitate the installation of the new arms with counterweights.

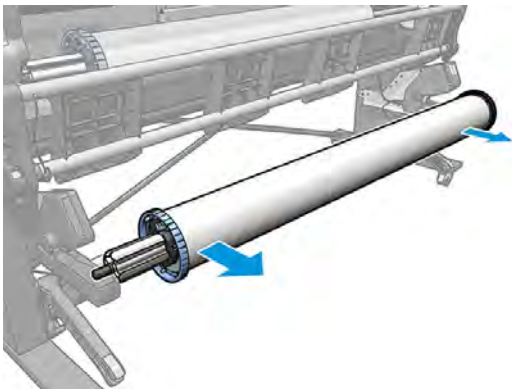



4. Install the subassembly on the left arm of the tension bar, by moving the arms upwards.

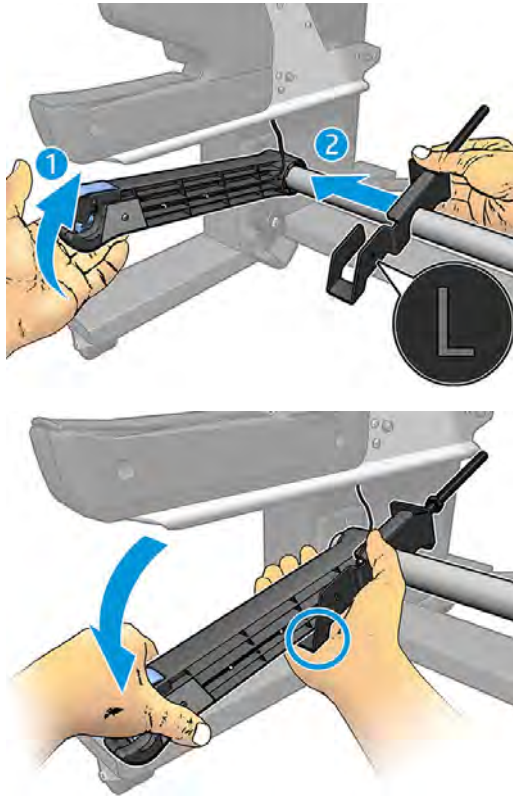

5. Install the subassembly on the right arm of the tension bar, by moving the arms upwards.

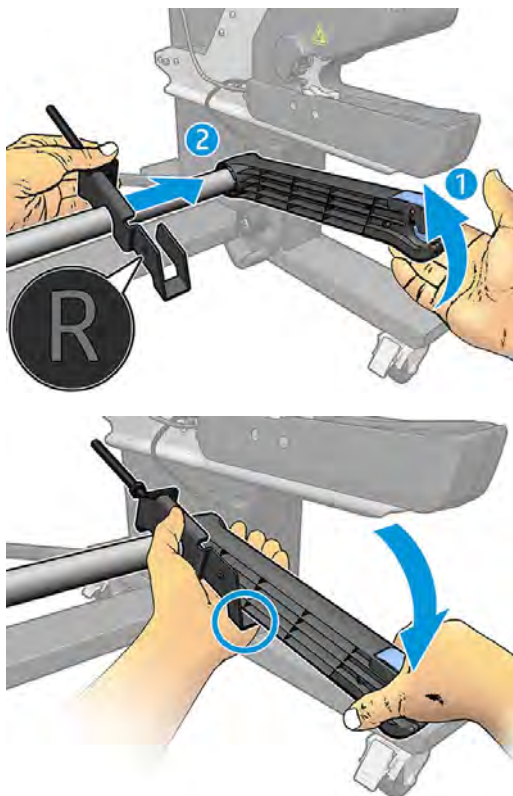

6. Correct the position of the tension bar after installing the arms.

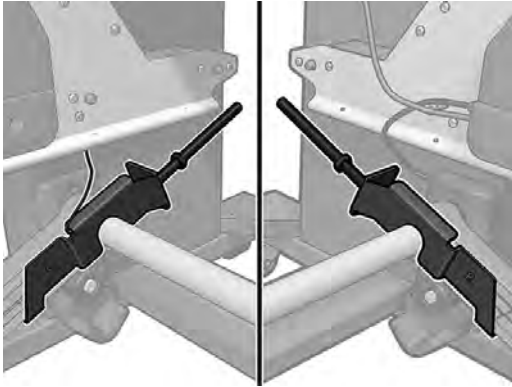

7. Install the weight at the end of the nut for most substrates. In some cases, you can move the weight forward to reduce the front tension for a particular substrate.

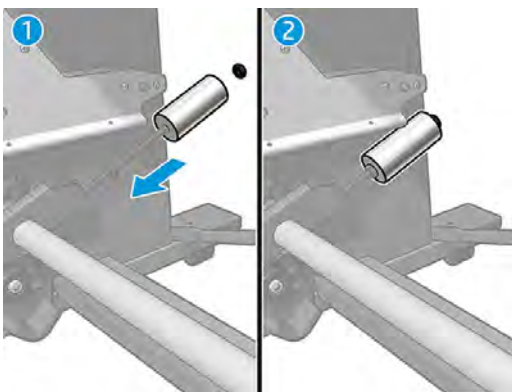

8. For a 64-inch printer: Keep the weights at the furthest position from the tension bar, to provide maximum counterweight torque.

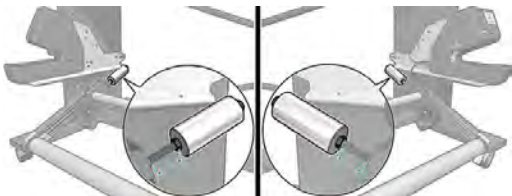

9. For a 54-inch printer: Move the left-hand weight as close as possible to the tension bar, to provide minimum counterweight torque. The right-hand weight should be as in the 64-inch configuration.

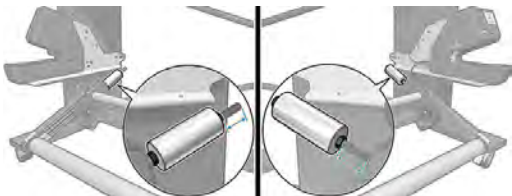

 **NOTE:** If you have an HP Latex 375 printer, you will probably need to move the ink tanks slightly to allow free movement of the arm.

---

## 6 Ink system

- [Ink cartridges](#)
- [Printheads](#)
- [Maintenance cartridge](#)
- [Safe mode](#)

### Ink cartridges

The printer's seven ink cartridges provide magenta, light magenta, black, yellow, light cyan, cyan, and optimizer ink to the printheads. Each cartridge has a capacity of 775 ml.



Ink cartridges require no maintenance or cleaning, but must be shaken before installation. High-quality printing results continue even when the ink levels are getting low.

HP Latex Optimizer enables high quality at high speed. HP Latex Optimizer consists of positively-charged (cationic) polymers suspended in a colorless, water-based ink vehicle. It reacts with the ink pigments, which are negatively-charged (anionic), to immobilize them rapidly on the print surface. This produces sharp text and image detail by suppressing feathering and color bleed especially at high productivity levels.

HP Latex Optimizer also enables the drying and curing process of the HP Latex inks to operate at lower temperatures and to be more energy-efficient, which has the additional benefits of allowing wide substrate support and reduced power consumption.

---

**⚠ CAUTION:** Avoid touching pins, leads, and circuitry when handling ink cartridges because these elements are sensitive to electrostatic discharge. Such devices are called ESD-sensitive devices. See [Glossary on page 179](#). Electrostatic discharges are one of the main hazards to electronics products. This type of damage can reduce the life expectancy of the device.

---

### Printheads

The printheads deposit ink on the substrate. Each printhead, except the optimizer printhead, is connected to two ink cartridges.

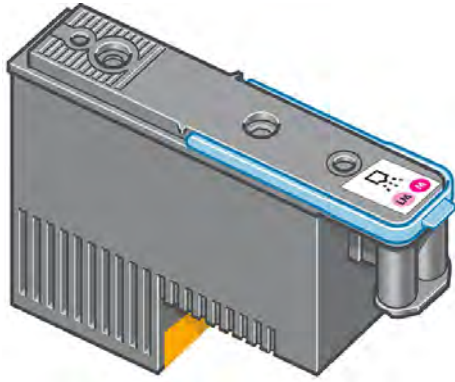

The printheads are extremely durable and do **not** need to be replaced every time an ink cartridge is replaced. They provide excellent results even when the ink cartridges contain a low level of ink.

To maintain optimum print quality, the printheads are automatically tested at regular intervals, and automatically serviced when necessary. This takes a little time and can occasionally delay printing.

When a printhead eventually needs to be replaced, the front panel will display a message.

---

**CAUTION:** Avoid touching pins, leads, and circuitry when handling printheads because these elements are sensitive to electrostatic discharge. Such devices are called ESD-sensitive devices. See [Glossary on page 179](#). Electrostatic discharges are one of the main hazards to electronics products. This type of damage can reduce the life expectancy of the device.

**CAUTION:** If you want to remove a printhead from the printer and preserve it for later use, reinstall the cap and plug, but never install a clear optimizer cap or white plug on a non-optimizer printhead. Optimizer printheads have clear caps and white plugs, while the other printheads have orange caps and plugs. Installing the wrong cap and plug can cause irrecoverable printhead damage.

---

## Maintenance cartridge

The maintenance cartridge cleans and maintains the printheads, and seals the printheads when they are not in use to prevent them from drying out. It is also used to store waste ink.

---

**IMPORTANT:** Keep the maintenance cartridge horizontal when removing it, to avoid spilling ink.

---

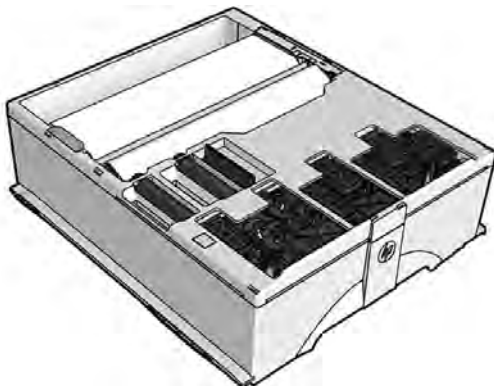

The cartridge contains a roll of cloth, which is used to clean the printheads. You are notified when 92% of the roll has been used, after which the cartridge should continue to function for about another 140 m<sup>2</sup> (1500 ft<sup>2</sup>) of printed area. A new roll lasts for about 1850 m<sup>2</sup> (20000 ft<sup>2</sup>) of printed area.

---

**NOTE:** These figures can vary considerably depending on the image density, the print mode, and the ambient temperature. The cloth will be exhausted much faster with a high-density print, many passes, and a hot environment.

---

 **NOTE:** The maintenance cartridge is checked to detect end of roll when the printer is turned on and at the end of each print job.

---

The printer will refuse to start a print job if it detects the end of the cleaning roll. You should then replace the maintenance cartridge with a new one.

## Safe mode

Under certain conditions, including printer operation outside of environmental specifications, and when a used, refilled, or counterfeit ink cartridge has been detected, the printer will operate in 'safe' mode. HP is unable to warrant the performance of the printing system when operated outside of environmental specifications or when a used, refilled, or counterfeit ink cartridge is installed. Safe mode is designed to protect the printer and the printheads from damage due to unexpected conditions, and is in operation when the  icon is displayed on the front panel. For optimal performance, use Original HP ink cartridges. HP Latex printing systems, including Original HP inks and printheads, are designed and engineered together to provide uncompromising print quality, consistency, performance, durability, and value—with every print.

 **NOTE:** This printer is not designed to use continuous ink systems. To resume printing, remove the continuous ink system and install genuine HP (or compatible) ink cartridges.

 **NOTE:** The printer's ink cartridges are designed to be used until they are empty. Refilling cartridges before they are empty could cause the printer to fail. If this happens, insert a new cartridge (genuine HP or compatible) to continue printing.

---

---

# 7 Hardware maintenance

For the tasks in this chapter, you may need the User Maintenance Kit that was provided with your printer.

- [Ink system tips](#)
- [Maintain the ink cartridges](#)
- [Replace an ink cartridge](#)
- [Cannot insert an ink cartridge](#)
- [Clean \(recover\) the printheads](#)
- [Align the printheads](#)
- [Front panel recommends reseating or replacing a printhead](#)
- [Replace a printhead](#)
- [Cannot insert a printhead](#)
- [Clean the electrical connections on a printhead](#)
- [Replace the maintenance cartridge](#)
- [Cannot insert the maintenance cartridge](#)
- [Clean and lubricate the carriage rod](#)
- [Clean the encoder strip](#)
- [Clean the platen](#)
- [Clean the substrate-advance sensor window](#)
- [Clean the exterior of the printer](#)
- [Move or store the printer](#)
- [Service maintenance](#)

## Ink system tips

For best results, always follow these guidelines:

- Follow the instructions on the front panel during installation.
- Allow the printer and the maintenance cartridge to clean the printheads automatically.
- Avoid unnecessary removal of the ink cartridges and printheads.
- The ink cartridges should never be removed while the printer is printing. They should be removed only when the printer is ready for you to replace them. The front panel guides you through the replacement procedure.
- Make sure that you comply with all applicable laws and regulations when disposing of ink system consumables.

---

 **NOTE:** Shake the ink cartridges and printheads vigorously before installing them.

---

## Maintain the ink cartridges

During the normal lifetime of a cartridge, no specific maintenance is required. You should replace a cartridge when it has reached its expiration date. See the ink cartridge information on the front panel for the expiration date.

## Replace an ink cartridge



Ink cartridges should be replaced for the following two reasons:

- The ink cartridge is very low and you want to replace it with a full cartridge for unattended printing. You can use the remaining ink in the first cartridge at a more convenient time.
- The ink cartridge is empty or faulty, and you must replace it to continue printing.

---

 **NOTE:** If an ink cartridge runs out of ink while printing, the front panel prompts you to replace the ink cartridge, the job is paused and will resume afterwards. This pause may affect the print quality of the job.

 **CAUTION:** The procedure to remove an ink cartridge must be initiated from the front panel. Do not remove an ink cartridge until the front panel prompts you. If you remove an ink cartridge incorrectly, the printer may subsequently reject that cartridge.

**CAUTION:** Remove an ink cartridge only if you are ready to insert another one.

**CAUTION:** Observe precautions when handling ink cartridges because they are ESD-sensitive devices. Avoid touching pins, leads, or circuitry.

 **WARNING!** Make sure that the printer wheels are locked (the brake lever is pressed down) to prevent the printer from moving.

---

## Remove an ink cartridge

1. On the printer's front panel, press , then **Replace ink cartridges**.

Alternatively, press , then **Ink > Replace ink cartridges**.

2. Grip the blue tab in front of the cartridge that you want to remove.

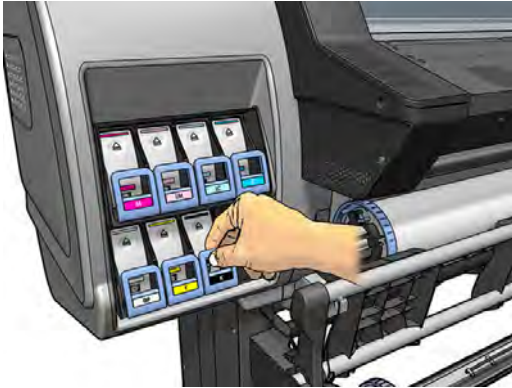

3. Pull the blue tab down and then pull it outwards, towards you.

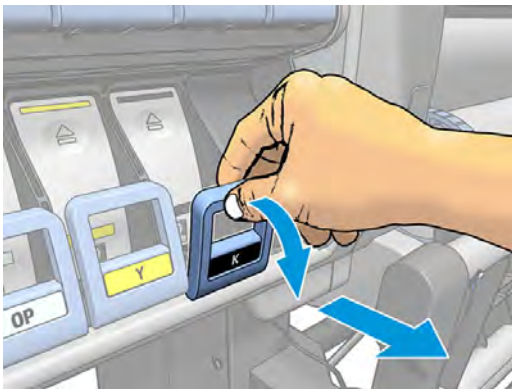



4. The cartridge comes out, in its drawer.



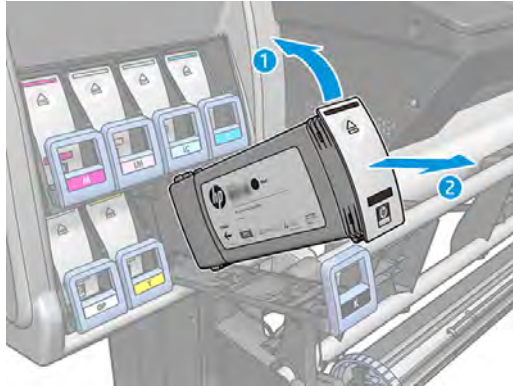

5. Lift the cartridge out of its drawer.



 **NOTE:** Avoid touching the end of the cartridge that is inserted into the printer, because the connection might be coated with ink.

 **NOTE:** If necessary, store a partially-used ink cartridge in the same position as if it were inserted in the printer. Avoid using a partially-used cartridge that has been stored on its end.

6. The front-panel display identifies the missing ink cartridge.



### Insert an ink cartridge

1. Pick up the new ink cartridge and find the label that identifies the ink color. Hold the ink cartridge so that you can see the label at the top of the side that is facing you.
2. Check that the colored label above the empty slot in the printer matches the color of the label on the cartridge.
3. Shake the cartridge vigorously for about 15 seconds.



4. Insert the ink cartridge into the cartridge drawer.

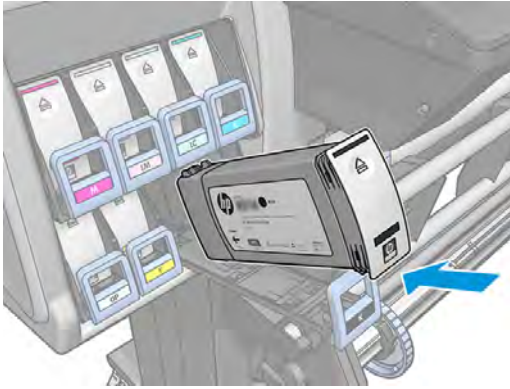

5. Slide the drawer and cartridge into the slot until they lock into position.

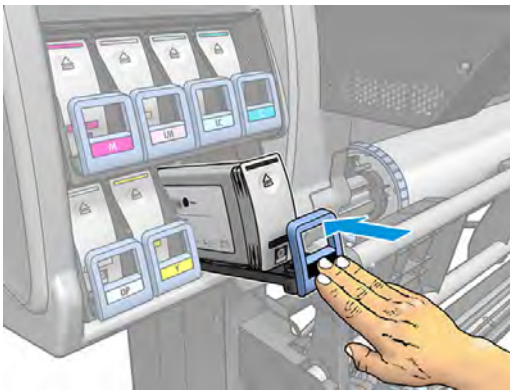

6. The front-panel display confirms that all cartridges have been correctly inserted.

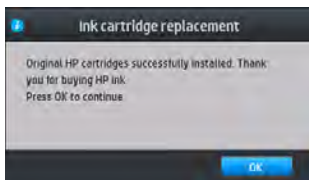

## Refilled and non-HP ink cartridges

HP recommends that you replace an empty cartridge with a new HP cartridge.

The use of refilled or non-HP ink cartridges has several disadvantages:

- If printer failure or damage is attributable to the use of a non-HP or refilled ink cartridge, HP will charge its standard time and materials charges to service the printer for the particular failure or damage, even if the printer is within its warranty period.
- If failure or damage to printheads, ink cartridges, or other ink supplies is attributable to the use of non-HP, expired or refilled ink cartridge, HP is not responsible for the cost of replacement.
- Print quality may be impaired.
- The printer will be unable to estimate the ink level in the cartridge, and will report it as empty.

If you decide to use refilled or non-HP ink cartridges, you will need to follow these instructions to make the printer use a cartridge that it believes to be empty.

---

**CAUTION:** Running completely out of ink can damage the printheads. Damage attributable to printing with empty ink cartridges is not covered under the warranty. Forcing the printer to accept empty cartridges will empty the ink delivery system as well. Once emptied, ink must be used to refill the system and reprime the printhead when a new ink cartridge is installed.

---

1. Install the cartridge in the printer (see [Replace an ink cartridge on page 129](#)).
2. The front panel will complain that the cartridge is empty, and the cartridge removal process will start. Press **X** to stop this automatic process.
3. On the front panel's home screen, press **Ink information** to display the following screen.

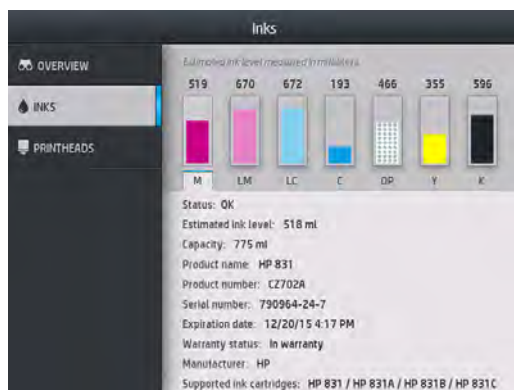

4. Press any cartridge to see more detailed information.
5. On the right-hand side of the front panel, press the following sequence: **X**, **X**, **?**, **?**. These icons are not illuminated; but, if you press them successfully, the front panel displays a series of warning messages. In response to each message, press **Cancel** to cancel the process, or **OK** to confirm that you wish to continue.
6. When you have pressed **OK** in response to all warning messages, the front panel gives the usual ink cartridge status display, but the cartridge is shown as empty with a warning sign.

## Cannot insert an ink cartridge

1. Check that you have the correct type of cartridge (model number).
2. Check that the colored label on the cartridge is the same color as the label on the slot.
3. Check that the cartridge is correctly oriented, the arrow on the front of the ink cartridge should face upwards.

---

**CAUTION:** Never clean inside the ink cartridge slots.

---

## Clean (recover) the printheads



Periodic printhead cleaning is performed automatically, as long as the printer is kept turned on. However, you should clean the printheads if you are experiencing poor print quality and cannot resolve the issues by other methods. This ensures that there is fresh ink in the nozzles and helps to prevent nozzle clogs.

If you have printed the printhead status plot (see [1. Printhead status plot on page 109](#)), you know which colors are failing. Clean any printhead that is not performing adequately. If you are not sure which printheads to clean, clean all of the printheads.

---

 **NOTE:** A small number of blocked nozzles are unlikely to have any visible effect on your prints, as the printer has been designed to compensate for this problem during multi-pass printing.

---

To clean the printheads (which often enables them to recover from problems), go to the printer's front panel and press , then **Image-quality maintenance > Clean printheads**, then select which printheads you want to clean. You can clean all of the printheads or only some of them. Select from the following options:

- Print test plot
- Clean all
- Clean LM-LC
- Clean K-C
- Clean M-Y
- Clean OP

Cleaning all printheads takes about 5 minutes. Cleaning any two printheads takes about 3 minutes.

---

 **NOTE:** Cleaning all printheads uses more ink than cleaning a single pair.

---

## Align the printheads

The printer performs printhead alignment whenever printheads are replaced. If no substrate is loaded when a printhead is replaced, the printer will perform the alignment the next time you load substrate.

You may also be recommended to align the printheads to solve a print-quality problem.

### Automatic alignment

First make sure that you have a roll of opaque, white substrate loaded in the printer. Colored substrates, glossy canvas, coarse textiles, and transparent materials such as translucent bond, clear film, tracing substrate and vellum are not suitable for automatic printhead alignment. For these substrates, you should align the printheads manually (see [Manual alignment on page 135](#)) or perform the automatic alignment on a supported substrate first, then change to the special substrate. Alignment settings are retained through substrate changes until a new printhead alignment is performed.

The HP Latex Optimizer can be aligned only on certain substrates such as self-adhesive vinyl. The pattern varies according to the substrate.

To request printhead alignment from the front panel (if the alignment is not performed automatically), press



, then **Image-quality maintenance > Align printheads > Auto printhead alignment**.

To request printhead alignment from the Embedded Web Server, select the **Setup** tab, then select **Printhead alignment > Automatic printhead alignment > Print**.

The process takes about 10 minutes and starts immediately, unless an image is currently being printed. If a print job is in progress, the alignment will be done as soon as the current print job is finished.

## Manual alignment

To request a manual printhead alignment from the front panel, press , then **Image-quality maintenance > Align printheads > Manual printhead alignment > Print alignment pattern.**

To request manual printhead alignment from the Embedded Web Server, select the **Setup** tab, then select **Printhead alignment > Manual printhead alignment > Print.**



The printer prints 16 rows labelled from A to P. Inspect the print and write down the number of the straightest line in each row (for example, A:9).

Patterns A and B are used to align the HP Latex Optimizer. These will be visible only on certain substrates, such as self-adhesive vinyl. If the best alignment pattern cannot be determined, the default value of 10 should be used.

Detail of pattern A



Detail of pattern B

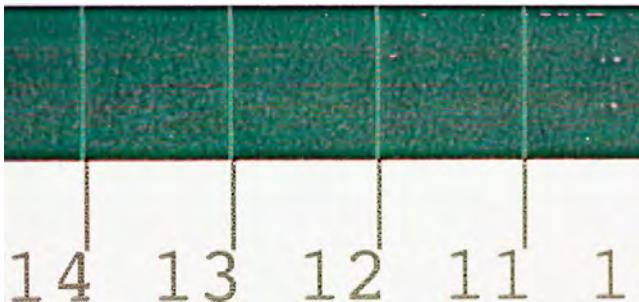

When you have made notes on each row, enter the correction values into the front panel or the Embedded Web Server.

To enter the correction values in the front panel, press , then **Image-quality maintenance > Align printheads > Manual printhead alignment > Enter correction values.** Enter each value into the window labelled with the same letter as the corresponding pattern.

To enter the correction values in the Embedded Web Server, select the **Setup** tab, then select **Printhead alignment** > **Manual printhead alignment**, and enter each value into the window labelled with the same letter as the corresponding pattern.

## Front panel recommends reseating or replacing a printhead

1. Remove the printhead and check that it is free from physical damage and from ink stains on the electrical connections.
2. If necessary, clean the electrical connections between the printhead and the carriage. See [Clean the electrical connections on a printhead on page 143](#).
3. Reinsert the printhead into the carriage and check the front panel message.
4. If the problem persists, insert a new printhead.

## Replace a printhead



### Remove a printhead

1. On the printer's front panel, press  (365/375) or the printheads icon (315/335), then **Replace printheads**.
2. The carriage moves to the removal position.

**⚠ CAUTION:** If the carriage remains in the removal position for more than 3 minutes without inserting or removing any printheads, it will attempt to return back to its home position to the right.

**CAUTION:** Observe precautions when handling printheads because they are ESD-sensitive devices. Avoid touching pins, leads, or circuitry.

3. When the carriage has stopped moving, the front panel prompts you to open the printer window.

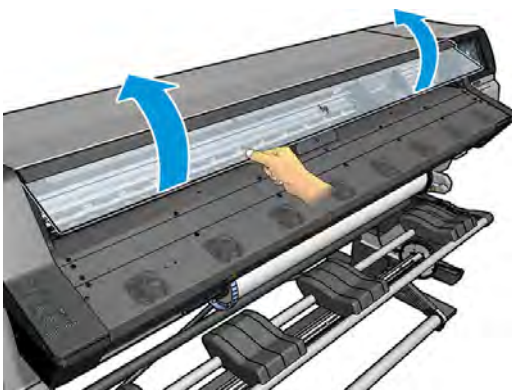

4. Locate the carriage on the right side of the printer.

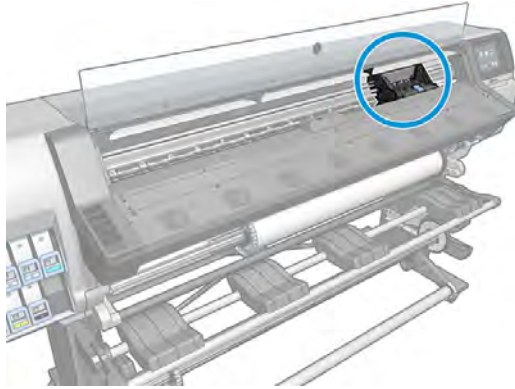

**⚠ CAUTION:** Avoid touching the printer's curing enclosure, which may be hot.

5. Pull up and release the latch on top of the carriage.

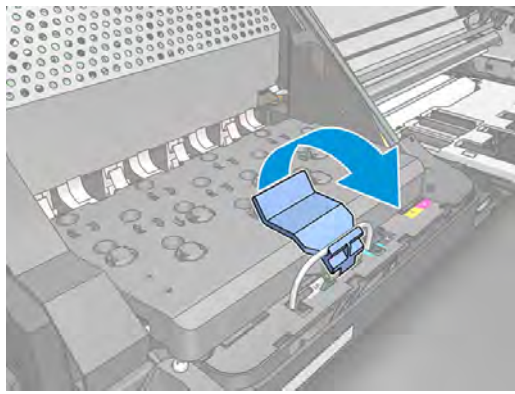

6. Lift up the cover. This provides access to the printheads.

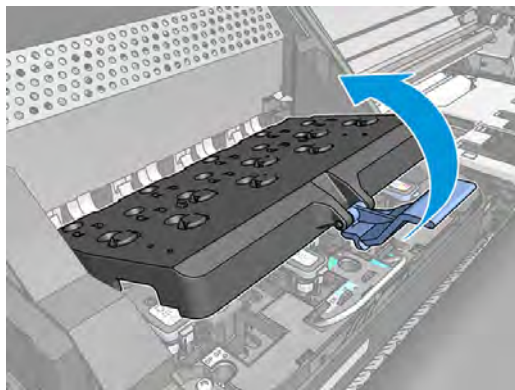

7. To remove a printhead, lift up the blue handle.

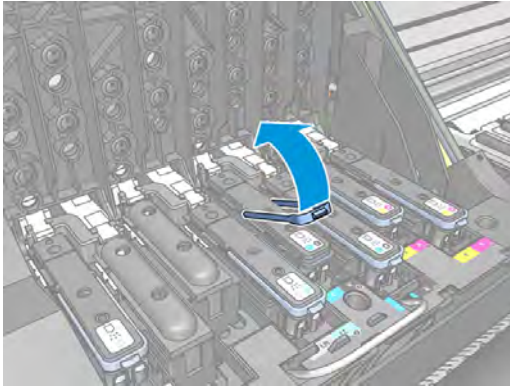

8. Using the blue handle, gently disengage the printhead.

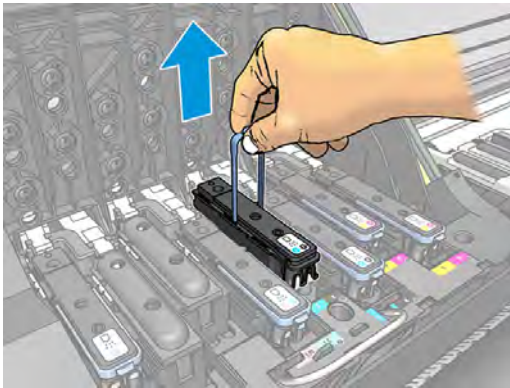

9. Gently pull the blue handle upward until the printhead is released from the carriage.

---

**⚠ CAUTION:** Do not pull abruptly. That action can damage the printhead.

---

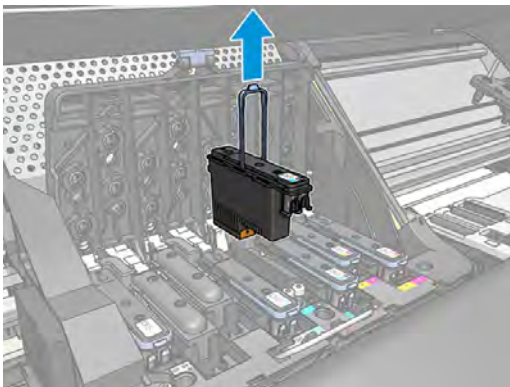

---

**⚠ CAUTION:** If you want to preserve the old printhead for later use, reinstall the cap and plug, but never install a clear optimizer cap or white plug on a non-optimizer printhead. Optimizer printheads have clear caps and white plugs, while the other printheads have orange caps and plugs. Installing the wrong cap and plug can cause irrecoverable printhead damage.

---



10. The front-panel display identifies the missing printhead.

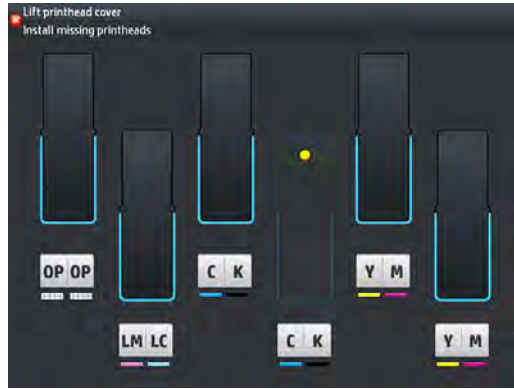

### Insert a printhead

1. If the printhead is new, shake it vigorously before removing the protective caps. Hold the printhead upright (with the protective caps facing down) and shake the printhead vigorously in a smooth up and down motion for about 15 seconds.

 **NOTE:** Be careful not to strike the printhead against anything while shaking it, because this could cause damage.



2. Remove the orange protective caps by pulling them down.

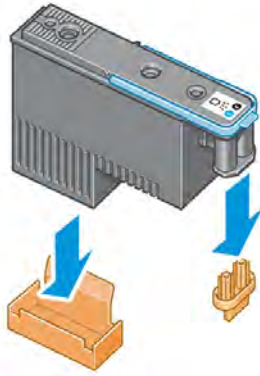

 **NOTE:** The optimizer protective caps are white or transparent.

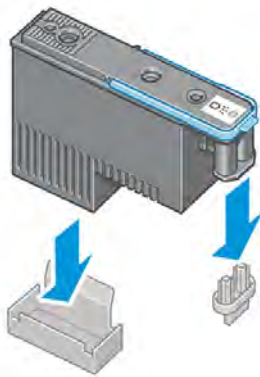

3. The printhead is designed to prevent you from accidentally inserting it into the wrong slot. Check that the colored label on the printhead matches the colored label of the carriage slot into which the printhead is to be inserted.
4. Insert the new printhead into its correct slot in the carriage.

 **CAUTION:** Insert the printhead slowly and vertically, straight down. It can be damaged if you insert it too quickly, or at an angle, or if you rotate it as you insert it.

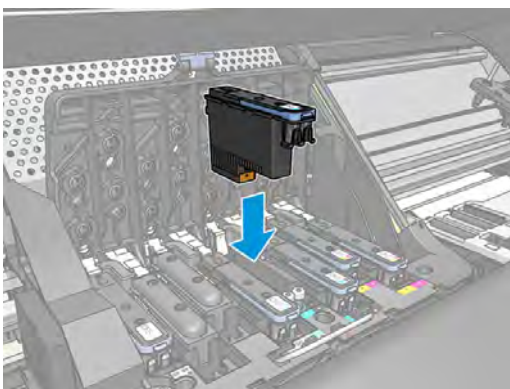

5. Push down as indicated by the arrow.

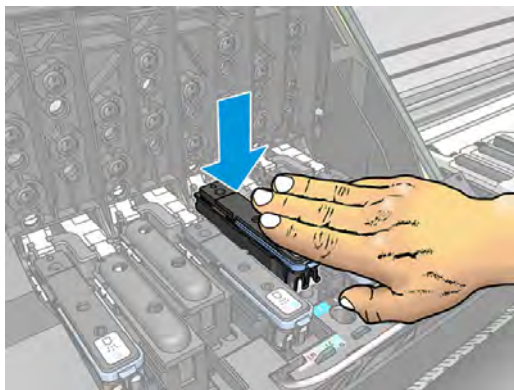

**⚠ CAUTION:** You might feel some resistance when installing the new printhead, so you need to press it down firmly but smoothly. You should hear a beep and see confirmation on the front-panel display that the printhead has been inserted.

6. Insert all of the other printheads that need to be installed, and close the carriage cover.

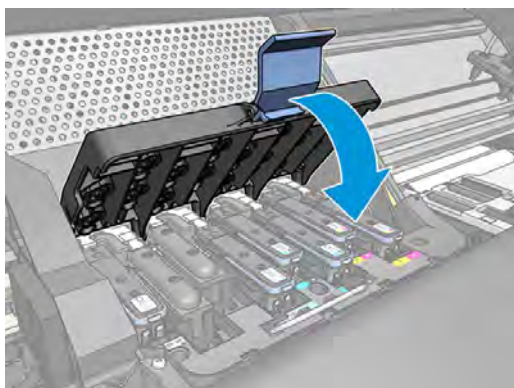

7. Make sure that the end of the latch catches the wire loop on the near side of the carriage.



- Lower the latch to rest on the carriage cover.

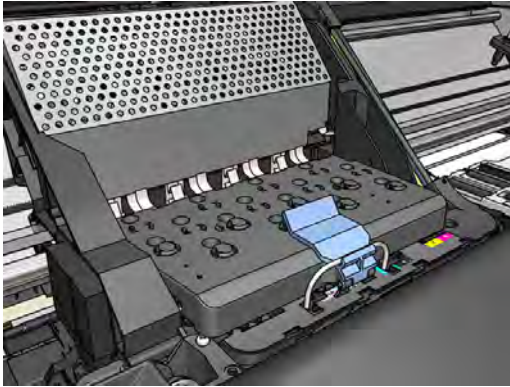

When all of the printheads have been inserted correctly and the printer has accepted them, the printer beeps.

---

 **NOTE:** If the printer does not beep when you insert the printhead and the **Replace** message appears on the front-panel display, you might need to reinsert the printhead.

---

- Close the printer window.

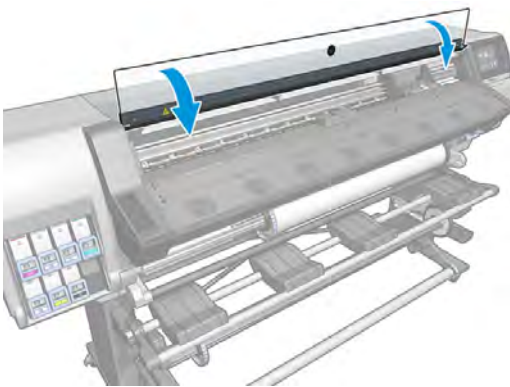

- The front-panel display confirms that all of the printheads are correctly inserted. The printer starts checking and preparing the printheads. The default routine process, when all printheads are changed, takes up to 18 minutes. If the printer identifies a problem when preparing the printheads, the process takes longer, up to 30 minutes. For a single printhead insertion, the time varies between 10 and 20 minutes. After all printheads are checked and prepared, the printhead realignment procedure runs automatically if substrate is loaded.

## Cannot insert a printhead

- Check that you have the correct type of printhead (model number).
- Check that you have removed the orange protective caps from the printhead.

---

 **NOTE:** Optimizer printhead caps are white or transparent.

---

- Check that the colored label on the printhead is the same color as the label on the slot.
- Check that the printhead is correctly oriented (compare with the others).
- Check that you have closed and latched the printhead cover.

## Clean the electrical connections on a printhead

It is possible that the printer will not recognize a printhead after it has been installed. This can happen when ink builds up on the electrical connections between the printhead and the printhead carriage. Under these circumstances, HP recommends that you clean the electrical connections on the printhead. However, routine cleaning of the connections when no problems are apparent is *not* recommended.

A carriage interconnect wiper is included with your printer in the User Maintenance Kit.

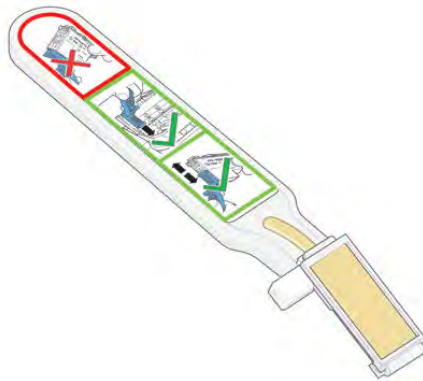

Use this to clean the electrical interconnects on both the printhead carriage and the printhead if the **Reset** or **Replace** message persists next to the printhead on the front-panel display.

---

 **TIP:** You are recommended to wear gloves.



- 
1. Remove a new pre-moistened replacement sponge from its pouch.

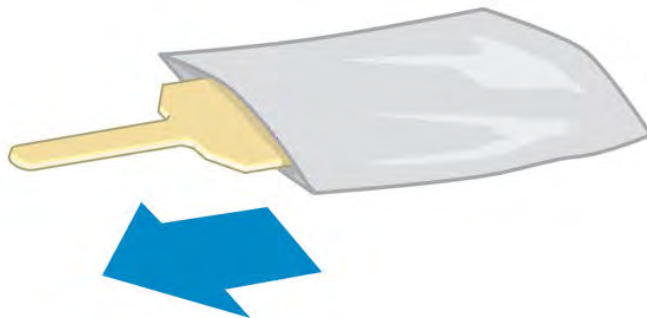

A supply of sponges is included in the box with the wiper. If all sponges have been used, more can be obtained by calling your service representative.

2. Open the carriage interconnect wiper.



3. Load the sponge by positioning the sponge on the face of the carriage interconnect wiper with the shorter tab in the locating slot.

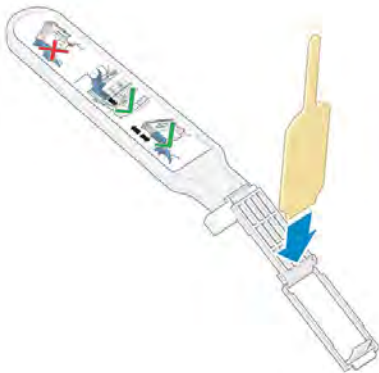

4. Close the carriage interconnect wiper, trapping the sponge in place.

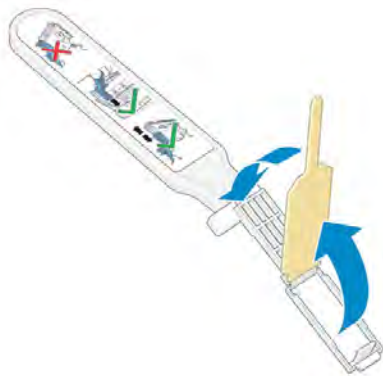

5. Open the printhead carriage latch and extract the printhead that is causing the problem, as indicated on the front panel. See [Replace a printhead on page 136](#).

6. Insert the carriage interconnect wiper into the printhead slot at the back. Wipe the electrical contacts by inserting the tool between the electrical connections at the back of the slot and the steel spring, with the sponge facing away from you and towards the electrical contacts. Try to avoid picking up any ink deposit that may have accumulated on the bottom surface of the slot.

**⚠ CAUTION:** If the carriage remains in the central part of the printer for more than 7 minutes, it attempts to return to its home position to the right.

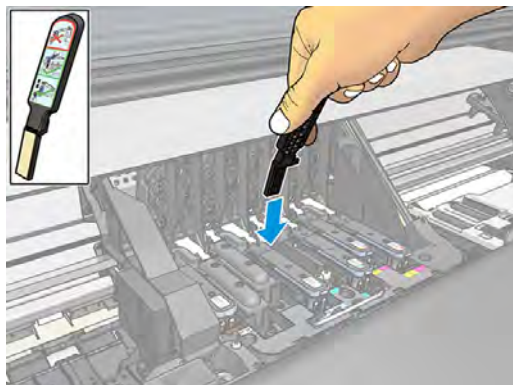

7. Rub the sponge against the contacts with a *light* force along the entire depth of the flex connector, inserting the wiper as far as allowed by the mechanical stop on the tool.

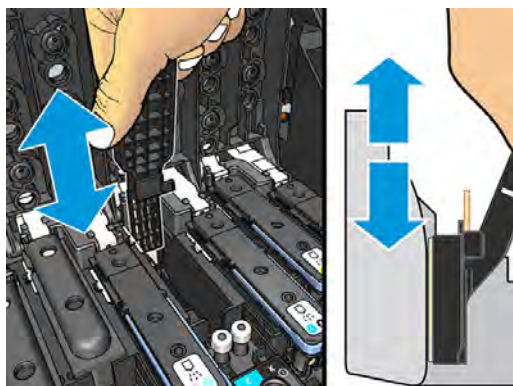

8. Take special care to clean all contacts thoroughly, including the ones at the lowest point of the connector.

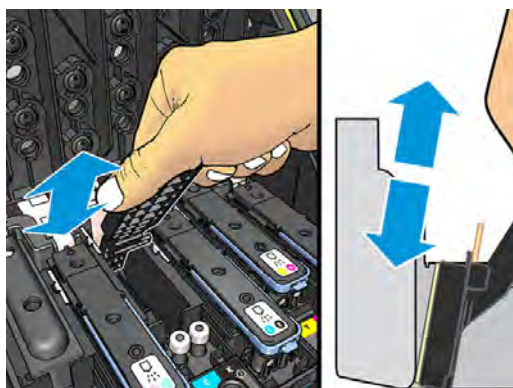

- Using the same sponge, clean the lower strip of electrical contacts on the printhead (unless the printhead is new). Avoid touching the upper set of electrical contacts.

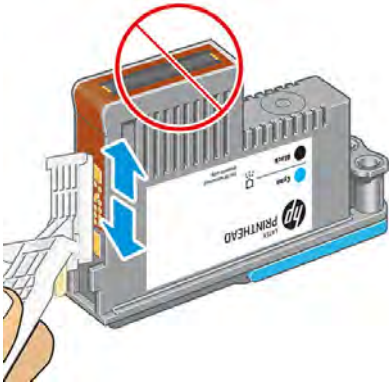

---

**CAUTION:** Do not touch the surface of the printhead that contains the nozzles, because the nozzles are easily damaged.

---

- After waiting a few moments to allow both connectors to dry, replace the printhead into the printhead carriage. See [Replace a printhead on page 136](#).
- After completing the cleaning process, open the carriage interconnect wiper by pulling on the sponge tab.

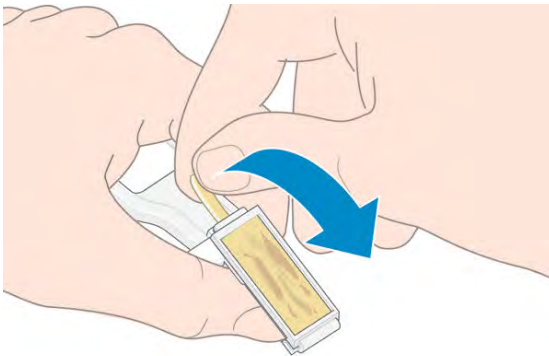

- Remove the soiled sponge from the carriage interconnect wiper.

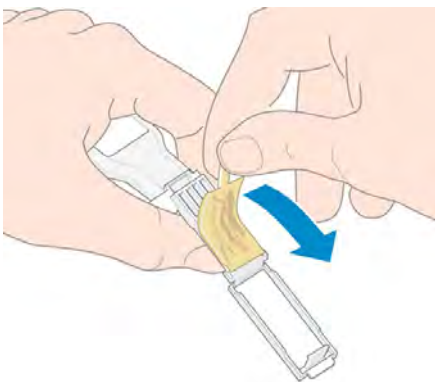



13. Dispose of the soiled sponge in a safe place to prevent the transfer of ink onto hands and clothing.

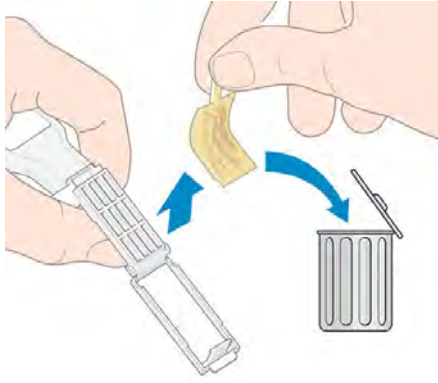

If the front panel continues to show the **Reset** or **Replace** message, replace the printhead or call your service representative.

## Replace the maintenance cartridge



You should replace the maintenance cartridge when prompted to do so by the front panel.

- 
-  **TIP:** If you want to remove and inspect the maintenance cartridge at any time, you can start the following procedure. If you put the old maintenance cartridge back into the printer after inspecting it, the procedure ends at that point.
- 

1. On the printer's front panel, press , then **Replace printhead cleaning kit**.



2. The maintenance cartridge is located in a slot underneath the front panel, at the front of the printer. Open the door.

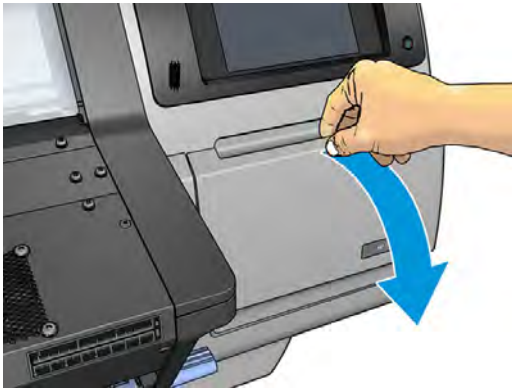

 **IMPORTANT:** When removing a maintenance cartridge, remember that it is full of ink. Therefore:

- Wear gloves.



- Remove it carefully and horizontally to avoid splashing.
- Always handle and store the replaced maintenance cartridge upright.

 **WARNING!** Make sure that the printer wheels are locked (the brake lever is pressed down) to prevent the printer from moving.

3. The maintenance cartridge has a handle on the front. To remove the cartridge, just slide it out.



4. When you have slid it out partway, hold it on each side with both hands: it is heavy.

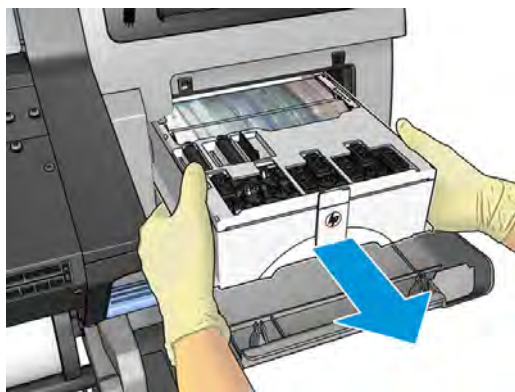

 **IMPORTANT:** Slide it out horizontally to avoid spills, as it is full of ink.



5. Remove the plastic cover from the new maintenance cartridge.

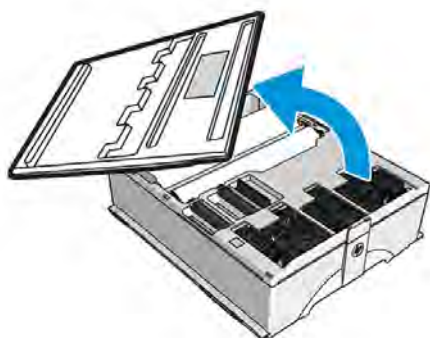

6. Insert the maintenance cartridge into the slot, in the direction indicated by the arrow.

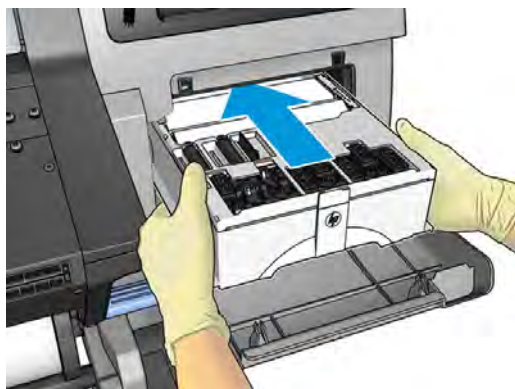

7. Push the maintenance cartridge in until it does not protrude from the slot. You will notice that the printer takes it; do not use excessive force.

---

 **NOTE:** The front panel will not show the new maintenance cartridge until the door is closed.

---

8. When you have inserted the maintenance cartridge into the printer, close the door.

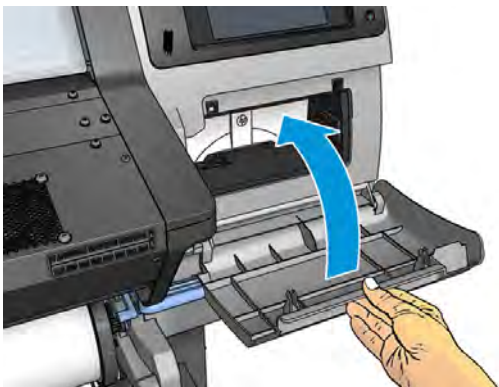

---

 **NOTE:** Before it can resume printing, the printer needs all the ink cartridges, printheads, and maintenance cartridge to be installed, and the printer window and maintenance cartridge door to be closed.

---

## Cannot insert the maintenance cartridge

Check that the maintenance cartridge has the correct model number and is correctly oriented.

## Clean and lubricate the carriage rod



---

 **NOTE:** In some circumstances, such as in ambient temperatures above the printer's operational specification (see [Environmental specifications on page 175](#)), or if there is a significant amount of dust in the air, the lubrication of the slider rods may be impaired, which can affect the performance of the printer.

---

The following procedure can also be found as a video here: <http://www.hp.com/go/latex300/videos>.

1. At the front panel, press , then **Preventive maint. tasks** > **Carriage rod lubrication**.
2. Open the window.
3. Clean the carriage rod using a lint-free cloth dampened with 95% ethanol. Take care to clean the whole rod, including the part under the left cover.

---

 **NOTE:** 95% ethanol is not provided in the Maintenance Kit.

 **CAUTION:** Ethanol is highly flammable. Observe the manufacturer's safety precautions.

**CAUTION:** Do not use commercial cleaners or abrasive cleaners.

**⚠ WARNING!** Avoid moving parts. You are recommended to wear gloves.



Moving part



Wear gloves

For more safety information, please see [Safety precautions on page 3](#)



**⚠ CAUTION:** While cleaning, be careful not to damage the plastic encoder strip located on top of the rod.

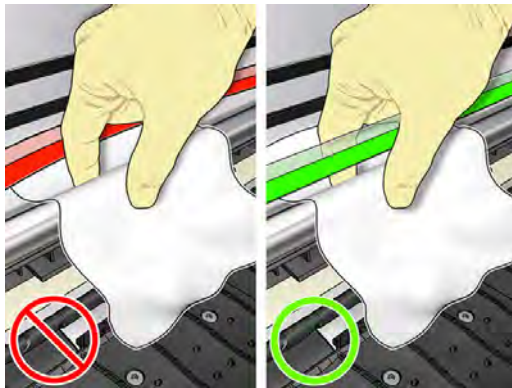

4. Wait until the rod is dry, then close the window. The carriage moves to the left side of the printer so that you can reach the part of the rod under the right cover.
5. Open the printer window.
6. Clean the carriage rod area under the right cover as described in step 3.
7. Take the bottle of oil from the Maintenance Kit that is supplied with your printer (a replacement kit can be ordered if necessary).

8. Deposit a very thin zig-zag trickle of oil along the rod.

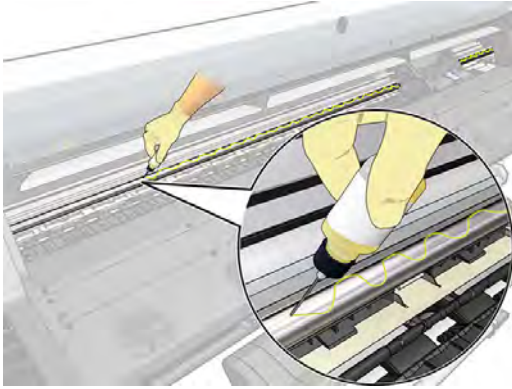

 **NOTE:** While lubricating, be careful not to drop oil on the encoder strip located on top of the rod.

9. Press **OK** at the front panel.
10. Close the window.
11. The carriage moves from one side of the printer to the other to distribute the oil along the rod.
12. The front panel asks you to confirm that lubrication has been completed. Press **OK** to confirm.

## Clean the encoder strip



Cleaning the encoder strip is a vital part of the printer's maintenance and can clear a variety of system errors:

- 86:01 or 87:01 system errors and related mispositioning of the carriage assembly errors, such as the carriage bumping into the side of the printer.
- 42:10 system errors, related to failures starting and homing the carriage on the scan axis.
- 29:01 system errors that cannot be cleared even after installing new maintenance cartridges.
- There are occasions when a dirty encoder strip can cause substrate loading issues, as the carriage cannot correctly detect the position of the substrate.

The encoder strip should be cleaned when requested by the printer. The front panel displays a message when cleaning is required: **For optimal printer performance follow the Clean the encoder strip process as described in the User's Guide.**

 **NOTE:** When the message is displayed on the front panel, a silent warning message is added within the system error log '8:01'. This helps when reviewing the error log history.

### Cleaning procedure

1. At the front panel, press , then **Preventive maintenance tasks > Clean scan axis encoder**.
2. Open the window.

3. Clean the encoder strip on both sides with a cloth dampened with water, as instructed in the front panel, and press **Continue** when finished.
4. Close the window. The carriage moves to the left-hand side of the printer.
5. The front panel prompts you to reopen the window and clean the right-hand side of the encoder strip (inside the service station). Press **Continue** when finished.
6. Close the window. The carriage returns to its ready position in the service station.

## Clean the platen

You should clean your print platen after every 40 liters of ink used (the front panel will remind you with an alert), and additionally when you notice any of the following symptoms:

- Ink smearing when printing with presets that used to work well (vacuum loss)
- More frequent substrate jams
- Ink stains and marks on the back of your prints
- Advance issues even when using the substrate-advance sensor

---

 **NOTE:** If you print on wide substrate after having printed on narrower substrate, you may find that the left side of the platen has become dirty. If this contaminated section of the platen is not cleaned, it could leave marks on the back of the substrate.

 **NOTE:** Do not print on porous substrates when using the platen, as it will get dirty. Use the ink collector for porous substrates.

 **NOTE:** If, when cleaning the platen, you see that any sticker is missing or out of place, you can replace it with one of the spare stickers provided in the User Maintenance Kit.

 **CAUTION:** Be careful not to damage the substrate-advance sensor when cleaning the platen. The sensor is the very small rectangular window (less than 1 cm<sup>2</sup>) found close to the third pinchwheel from the right. See [Clean the substrate-advance sensor window on page 154](#).

 **TIP:** You are recommended to wear gloves.



---

Follow these instructions to clean the platen.

1. Unload all substrate from the printer. See [Unload a roll from the printer on page 68](#).
2. Turn off the printer.
3. Open the printer window.
4. Use a 1 mm pin to unclog every hole in the print platen. Make sure to push the pin all the way through. Remains of ink and substrate fibers tend to accumulate in the holes and diminish the vacuum effect.
5. Remove the platen or ink collector. See [Ink collector \(365 and 375 only\) on page 55](#).
6. With the same 1 mm pin or tweezers, remove all remains of ink and substrate fibers inside the vacuum suction cups.
7. Reinstall the platen or ink collector.

If you find ink stains on the back of your prints or have trouble with the substrate-advance sensor, continue with the following steps:

1. Use a clean, absorbent lint-free cloth to wipe any wet ink thoroughly from the cutter groove, cutter ramp, and platen.
2. With a dry brush, remove dry, loosened ink deposits from the cutter groove and cutter ramp.

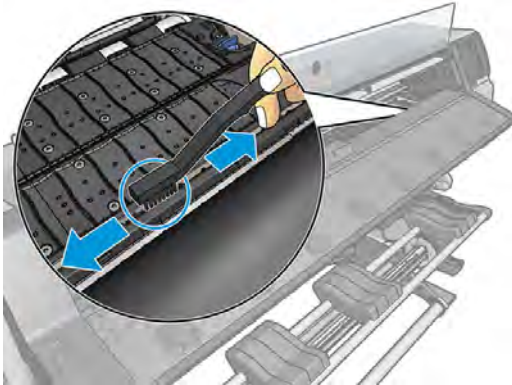

3. With the same dry brush, remove dry, loosened ink deposits from the platen surface.

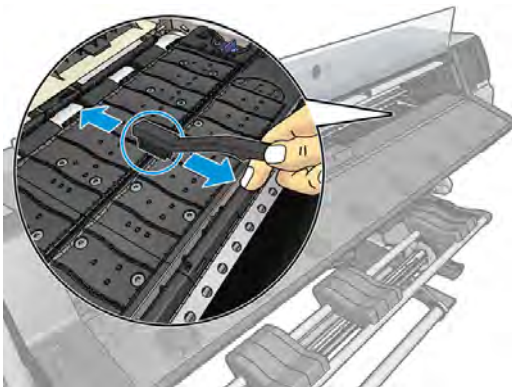

4. Slightly dampen the used cloth with 95% ethanol to wipe the remaining dry ink deposits from the platen.

 **NOTE:** Dry ink deposits take longer to remove.

 **NOTE:** 95% ethanol is not provided in the User Maintenance Kit.

 **CAUTION:** Ethanol is highly flammable. Observe the manufacturer's safety precautions.

**CAUTION:** Do not use commercial cleaners or abrasive cleaners. Do not wet the platen directly, because you will leave too much moisture behind, which could damage the substrate advance sensor.

5. Use the damp cloth to remove remaining dry ink deposits from the cutter ramp.
6. Close the 95% ethanol container and remove it and the cloth from the vicinity of the printer.
7. Wait 3 or 4 minutes to let the ethanol evaporate, before turning on the printer and reloading the substrate.

## Clean the substrate-advance sensor window

The substrate-advance sensor is the very small rectangular window (less than 1 square centimeter in size) close to the third pinchwheel from the right.

HP recommends that you clean the substrate-advance sensor window whenever you clean the print platen and if you are experiencing print quality issues.



1. Unload the substrate by using the front panel procedure. See [Unload a roll from the printer on page 68](#).
2. Turn off the printer and wait until it has cooled down.
3. Wipe the sensor with a cotton swab to remove wet ink.

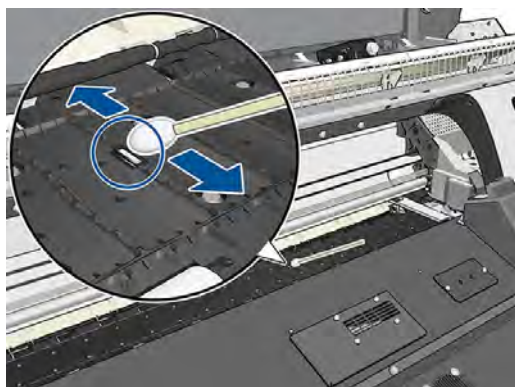

4. Wipe the sensor with a cotton swab, slightly dampened with 95% ethanol, to remove dried ink.

---

 **NOTE:** 95% ethanol is not provided in the User Maintenance Kit. Please follow the manufacturer's safety precautions when handling ethanol.

---

If the sensor window is heavily coated with dried ink, you may need to apply some pressure while wiping, helping the cotton to absorb the ink. Continue cleaning with fresh swabs until the cotton stays clean and the sensor window looks clean. When reflecting ambient light, a clean sensor shows a blue-colored reflection that should extend uniformly across its whole surface. You can see this reflection by moving closer and slightly changing your angle of view.

5. Remove the closed 95% ethanol container and the cotton swabs from the vicinity of the printer.
6. Wait three or four minutes to let the ethanol evaporate, before turning on the printer and reloading the substrate.

## Clean the exterior of the printer

Use a damp sponge or a soft cloth and a mild household cleaner such as non-abrasive liquid soap to clean the outside of the printer and all other parts of the printer that you regularly touch as part of normal operation.

There may be some dampness from condensation under the fans of the curing module, which should be wiped with a dry cloth.

---

 **WARNING!** To avoid an electric shock, make sure that the printer is turned off and unplugged before you clean it. Do not let water get inside the printer.

 **CAUTION:** Do not use abrasive cleaners on the printer.

---

## Move or store the printer

If you need to move your printer or store it for an extended period of time, prepare it correctly to avoid possible damage.

1. Do not remove the ink cartridges, printheads or maintenance cartridge.
2. Make sure that no substrate is loaded.
3. Make sure that the printhead carriage is located in the service station (at the right end of the printer).
4. Make sure that the **Ready** message appears on the front panel.

5. Turn off the power by using the [Power](#) button on the front panel.
6. Also switch off the power switch at the rear of the printer.
7. Disconnect any cables that connect the printer to a network, a computer, or a scanner.
8. If you intend to turn the printer upside down or on its side, first remove the maintenance cartridge (see [Replace the maintenance cartridge on page 147](#)).
9. For correct environmental storage conditions, see [Environmental specifications on page 175](#).



**NOTE:** If the printer or ink cartridges are moved from a cold location to a warm and humid location, water from the atmosphere can condensate on the printer parts and cartridges and can result in ink leaks and printer errors. In this case, HP recommends that you wait at least 3 hours before turning on the printer or installing the ink cartridges, to allow the condensate to evaporate.

## Service maintenance

During the life of your printer, components that are used constantly can wear out.

To avoid having these components degrade to the point that the printer breaks down, the printer keeps track of various parameters such as the line sensor degradation, the number of cycles that the carriage makes across the axis of the printer, and the total quantity of ink used.

The printer uses these numbers to track the need for service maintenance, and displays one of the following messages on the front panel:

- **Service Maintenance Kit 1**
- **Service Maintenance Kit 2**
- **Service Maintenance Kit 3**

These messages mean that some components are nearing the end of their lives. You can continue printing for quite some time, depending on your use of the printer. However, HP strongly recommends that you call your service representative and arrange for a service maintenance visit. The service engineer can then replace the worn parts on-site, which will prolong the life of the printer.

The benefits of arranging a service engineer's visit when these messages appear on the front panel are two-fold:

- The printer components can be replaced at a time that is convenient for you, and so will not disturb your daily workflow.
- During a service maintenance visit, the service engineer replaces several parts at once. This eliminates the need for repeat visits.

---

## 8 Firmware update



The printer's various functions are controlled by software that resides in the printer, also known as firmware.

From time to time, firmware updates from HP become available. These updates increase the printer's functionality and enhance its features.

### Firmware update using a USB flash drive

When installing the printer for the first time you may be asked to update the firmware. For this purpose, you need a USB flash drive with the following specifications:

- USB 2.0-compatible
- 2 GB capacity
- FAT32 preformatted
- No hardware encryption

#### Perform the firmware update

1. Download the firmware update from <http://www.hp.com/go/latex300/support/> and store it on the USB flash drive.



---

**IMPORTANT:** The USB flash drive should contain only one firmware file (.fmw) in the drive's root folder, and no other files.

---

2. Turn off the printer.
3. Connect the USB flash drive to the USB connector at the rear of the printer.
4. Turn on the printer.
5. Follow the instructions on the front panel.

Subsequent firmware updates can be installed in your printer in the same way, or by using the printer's Embedded Web Server.

## Firmware update using the Embedded Web Server

1. To access the Embedded Web Server from any computer, see [Check printer status on page 26](#).
2. In the Embedded Web Server, select the **Setup** tab and then **Firmware update** > **Manual firmware update**.
3. Follow the on-screen instructions to download the firmware file from <http://www.hp.com/go/latex300/support/> and store it on your hard disk. Then select the downloaded .fmw file and click **Update**.

If you experience very slow progress while uploading the firmware file to the printer, the reason could be that you are using a proxy server. In that case, try bypassing the proxy server and accessing the Embedded Web Server directly.

- In Internet Explorer for Windows, go to **Tools** > **Internet Options** > **Connections** > **LAN Settings**, and select the **Bypass proxy server for local addresses** check box. Alternatively, for more precise control, click the **Advanced** button and add the printer's IP address to the list of exceptions, for which the proxy server is not used.
- In Firefox for Windows, go to **Tools** > **Options** > **Network** > **Connection** > **Settings**, and select the **Direct connection to the Internet** check box. Alternatively, when the **Manual proxy configuration** check box is selected, add the printer's IP address to the list of exceptions, for which the proxy server is not used.
- In Firefox for Linux, go to **Edit** > **Preferences** > **Network** > **Connection** > **Settings**, and select the **Direct connection to the Internet** check box. Alternatively, when the **Manual proxy configuration** check box is selected, add the printer's IP address to the list of exceptions, for which the proxy server is not used.

## Automatic firmware updates

Automatic firmware updates are a convenience that is possible with Web-connected printers. Your printer can automatically download the latest firmware release and install it for you.

### Important notes

- Your printer must be connected to the Internet.
- To configure automatic firmware updates, you can use:
  - Front panel: , then **Updates** > **Firmware update**.
  - Embedded Web Server: **Setup** > **Firmware update** > **Firmware update settings**.
- If an administrator password has been set, it will be required to change these settings.
- A firmware update package can be large; you may want to consider whether there are any implications for your network or Internet connection.
- A firmware update is downloaded in the background: the printer can be printing at the same time. However, it cannot be installed in the background: printing must stop.

# 9 Accessories



There are two alternative ways to order supplies or accessories:

- Visit <http://www.hp.com/go/latex300/accessories> on the Web. There you will also see the latest list of supplies and accessories for your printer.
- Contact HP Support (see [When you need help on page 38](#)), and check that what you want is available in your area.

The rest of this chapter lists the available supplies and accessories, and their part numbers, at the time of writing.

## Order ink supplies

You can order the following ink supplies for your printer.

### Ink cartridges

Cartridge
HP 831A 775 ml Black Latex Ink Cartridge
HP 831B 775 ml Black Latex Ink Cartridge
HP 831C 775 ml Black Latex Ink Cartridge
HP 831A 775 ml Cyan Latex Ink Cartridge
HP 831B 775 ml Cyan Latex Ink Cartridge
HP 831C 775 ml Cyan Latex Ink Cartridge
HP 831A 775 ml Magenta Latex Ink Cartridge
HP 831B 775 ml Magenta Latex Ink Cartridge
HP 831C 775 ml Magenta Latex Ink Cartridge
HP 831A 775 ml Yellow Latex Ink Cartridge
HP 831B 775 ml Yellow Latex Ink Cartridge
HP 831C 775 ml Yellow Latex Ink Cartridge

## Ink cartridges (continued)

### Cartridge

HP 831A 775 ml Light Cyan Latex Ink Cartridge

HP 831B 775 ml Light Cyan Latex Ink Cartridge

HP 831C 775 ml Light Cyan Latex Ink Cartridge

HP 831A 775 ml Light Magenta Latex Ink Cartridge

HP 831B 775 ml Light Magenta Latex Ink Cartridge

HP 831C 775 ml Light Magenta Latex Ink Cartridge

HP 831 775 ml Optimizer Latex Ink Cartridge

## HP Latex 3-liter ink cartridges (375 only)

### Cartridge

HP 871A 3-liter Black Latex Ink Cartridge

HP 871B 3-liter Black Latex Ink Cartridge

HP 871C 3-liter Black Latex Ink Cartridge

HP 871A 3-liter Cyan Latex Ink Cartridge

HP 871B 3-liter Cyan Latex Ink Cartridge

HP 871C 3-liter Cyan Latex Ink Cartridge

HP 871A 3-liter Magenta Latex Ink Cartridge

HP 871B 3-liter Magenta Latex Ink Cartridge

HP 871C 3-liter Magenta Latex Ink Cartridge

HP 871A 3-liter Yellow Latex Ink Cartridge

HP 871B 3-liter Yellow Latex Ink Cartridge

HP 871C 3-liter Yellow Latex Ink Cartridge

HP 871A 3-liter Light Cyan Latex Ink Cartridge

HP 871B 3-liter Light Cyan Latex Ink Cartridge

HP 871C 3-liter Light Cyan Latex Ink Cartridge

HP 871A 3-liter Light Magenta Latex Ink Cartridge

HP 871B 3-liter Light Magenta Latex Ink Cartridge

HP 871C 3-liter Light Magenta Latex Ink Cartridge

HP 871A 3-liter Optimizer Latex Ink Cartridge

HP 871B 3-liter Optimizer Latex Ink Cartridge

HP 871C 3-liter Optimizer Latex Ink Cartridge

## Printheads

### Printhead

### Part number

HP 831 Cyan/Black Latex Printhead

CZ677A

### Printheads (continued)

Printhead	Part number
HP 831 Yellow/Magenta Latex Printhead	CZ678A
HP 831 Light Magenta/Light Cyan Latex Printhead	CZ679A
HP 831 Latex Optimizer Printhead	CZ680A

### Other supplies

Kit	Part number
HP 831 Latex Maintenance Cartridge	CZ681A

## Order accessories

The following accessories can be ordered for your printer, depending on which printer model you have: see [Printer models on page 2](#).

 **TIP:** Spare spindles ease the process of switching between different substrates.

### Accessories

Name	Part number
HP Latex 54-in Printer 2-in Spindle	F0M55A
HP Latex 64-in Printer 2-in Spindle	F0M56A
HP Latex 64-in Printer 3-in Spindle	F0M58A
HP Latex 300 54-in Take-Up Reel	W5A60A
HP Latex 300/500 User Maintenance Kit	F0M59A
HP Latex 300/500 Ink Collector	T7U74A

---

# 10 Troubleshoot other issues

- [Printer cannot get an IP address](#)
- [Cannot access the Embedded Web Server](#)
- [Printer is not printing](#)
- [The software program slows down or stalls while generating the print job](#)
- [Printer seems slow](#)
- [Communication failures between computer and printer](#)
- [Cannot connect to services such as firmware update, online search, or the Printer Data Sharing Agreement](#)
- [Front-panel error codes](#)





## Printer cannot get an IP address

If your network has no DHCP server, the printer cannot automatically retrieve an IP address. In this case, you must set the printer's IP address manually, in the following way.

1. From the front panel, press , then **Setup > Network connectivity > Gigabit Ethernet > Modify configuration > TCP/IP > IPV4 settings > Config method > Manual**.
2. From the IPV4 Settings menu, select **Manual settings > IP address**.
3. Enter the IP address that you wish to use, and press the **OK** key when finished.

## Cannot access the Embedded Web Server

If you have not done so already, please read the instructions in [Access the Embedded Web Server on page 23](#).

1. Go to the front panel and press , then **Connectivity > Network Connectivity > Advanced > Allow EWS > On**.
2. Press , then **Connectivity > Network information**.
3. The information should read: **IP enabled: Yes**. If it does not, you might need to use a different connection.

If you still cannot access the Embedded Web Server, turn the printer off with the **Power** button on the front panel and then turn it on again.

If you experience very slow progress while trying to access the Embedded Web Server, the problem could be that you are using a proxy server. Try bypassing the proxy server and accessing the Embedded Web Server directly.

- In Internet Explorer 6 for Windows, go to **Tools > Internet Options > Connections > LAN Settings**, and select the **Bypass proxy server for local addresses** check box. Alternatively, for more precise control, click the **Advanced** button and add the printer's IP address to the list of exceptions, for which the proxy server is not used.
- In Firefox 3.0 for Windows, go to **Tools > Options > Network > Connection > Settings**, and select the **Direct connection to the Internet** check box. Alternatively, when the **Manual proxy configuration** check box is selected, add the printer's IP address to the list of exceptions, for which the proxy server is not used.
- In Firefox 2.0 for Linux, go to **Edit > Preferences > Network > Connection > Settings**, and select the **Direct connection to the Internet** check box. Alternatively, when the **Manual proxy configuration** check box is selected, add the printer's IP address to the list of exceptions, for which the proxy server is not used.

## Printer is not printing

If a file you have sent from your computer is not printing when expected, the possible reasons include the following:

- There may be a problem with the electrical power. If the printer is not performing and the front panel does not respond, check that the power switch at the rear is on, the power cable is correctly connected, and the electrical socket is providing power.
- The network cable is disconnected, or you have problems with your communications setup. See [Communication failures between computer and printer on page 165](#), or contact your IT department or communications system provider.
- Check all the alerts on the front panel—there may be more than one, hidden under the first—by dragging down the top bar of the home screen. The alerts may explain why printing has stopped, such as:

- An ink supply is empty.
- A printhead is missing or damaged.
- The substrate is mispositioned.
- Check that the job in your RIP software is configured to be printed on the same substrate that you have selected in the front panel (the details of this operation may vary depending on your RIP software). Check that the loaded substrate is wide enough for your image plus the required margins.
- The roll has a length tracking option activated. Check that the remaining length of your roll is enough for your job. This information can be found from the  icon in the front panel or in your RIP software (the location of the menu may vary depending on your RIP software).
- In some very unlikely scenarios, the substrate preset you are using may be corrupted due to transfer synchronization issues. Try printing with a generic preset; if this prints well, you can fix the problem by deleting the troublesome preset from the substrate library in the front panel and the RIP software. Then reinstall the substrate, either manually or from the online search in the front panel.
- Unusual electromagnetic phenomena may exist, such as strong electromagnetic fields or severe electrical disturbances. Such occurrences can cause the printer to behave strangely, or even stop working. Turn off the printer by using the power button on the front panel, wait until the electromagnetic environment has returned to normal, then turn the printer on again. If the problems persist, call your service representative.

## The software program slows down or stalls while generating the print job

Large quantities of data might be necessary to generate a high-quality large-format print job. This can cause your software to slow down significantly or stall. Lowering the print resolution may help to avoid this problem; however, lowering the print resolution reduces print quality. See your software documentation.

## Printer seems slow

Here are some possible explanations.

- If you request the highest possible print quality in the RIP, printing will be relatively slow compared with draft-quality printing.
- Check that the substrate loaded in the printer belongs to the substrate family that appears on the front panel.
- Is your printer connected to a network? Check that all components used in the network (network interface cards, hubs, routers, switches, and cables) are capable of Gigabit Ethernet operation. Is there a lot of traffic from other devices on the network?
- Are the printheads in good condition? Printing time tends to increase when a printhead needs cleaning. Check the printhead status on the front panel or through the Embedded Web Server. Clean or replace printheads if necessary.
- Does your image contain high-density black fills? That may increase printing time.

See also [Printer states on page 18](#).

## Communication failures between computer and printer

Some symptoms are:



- The front-panel display does not show the **Receiving** message when you have sent an image to the printer.
- Your RIP shows an error message when you try to print, such as error 61:09 or 63:05. See [Front-panel error codes on page 166](#).
- Your RIP stalls when transferring data.

To solve a communication problem:

- Make sure that you have selected the correct printer in your RIP.
- Remember that large images usually require more time to receive, process, and print.
- If the printer is connected to your RIP through any other intermediate devices, such as switch boxes, buffer boxes, cable adapters, or cable converters, remove the intermediate device and try connecting the printer directly to your computer.
- Try another interface cable.
- Try changing the I/O timeout, which specifies the time that an idle connection is allowed to remain open when the printer is waiting for a remote computer. The default value is 270 seconds. To change the I/O timeout, go to the Embedded Web Server and select the **Networking** tab, then the **Advanced** tab.

## Cannot connect to services such as firmware update, online search, or the Printer Data Sharing Agreement

If your printer has difficulty in connecting to the Internet, it may start the Connectivity Wizard automatically. You can also start the wizard manually at any time.

- From the front panel: Press , then **Connectivity > Connectivity wizard**.
- From the front panel: Press , then **Internal prints > Service information prints > Print connectivity config**. In this case, the results are printed out.

---

 **NOTE:** The results printed out are from the last run of the Connectivity wizard, so you must already have run the Connectivity wizard in order to get any results.

---

The Connectivity Wizard performs a series of tests automatically. You can also choose to perform individual tests. From the front panel, press , then **Connectivity > Diagnostics & troubleshooting**. The following options are available.

- **All tests**
- **Network connectivity test:** Check the printer's connection to the local area network.
- **Internet connectivity test:** Check the printer's connection to the Internet.
- **Firmware update test:** Check the printer's connection to HP's firmware update servers.
- **Email server test:** Check the printer's connection to the configured email server.
- **Printer Data Sharing Agreement test:** Check the printer's connection to the PDSA.
- **HP Media Locator configuration settings:** Check that you can access the online substrate preset library.

Alternatively, these tests can be launched from the Embedded Web Server: select **Support > Connectivity troubleshooting**.

If any test fails, the printer describes the problem and recommends how to solve it.

## Front-panel error codes



Under certain circumstances, a numeric error code appears on the front panel. Follow the advice in the Recommendation column to resolve the error. If the recommendation does not seem to solve the problem, call your service representative. See [When you need help on page 38](#).

If an error code appears on the front panel that is *not* included in this list, turn off the printer and then turn it back on. If the problem persists, call your service representative.

Error code	Recommendation
03.21:01	PSU undervoltage detected. <ol style="list-style-type: none"><li>1. Turn off the printer and unplug both power cords.</li><li>2. Check that the power cords are not visibly damaged.</li><li>3. Ensure that the input voltage is within specifications (180–264 V AC).</li><li>4. Plug in both power cords and make sure they are fully inserted.</li><li>5. Turn on the printer.</li></ol>
03.22:01	PSU overvoltage detected. <ol style="list-style-type: none"><li>1. Turn off the printer and unplug both power cords.</li><li>2. Check that the power cords are not visibly damaged.</li><li>3. Ensure that the input voltage is within specifications (180–264 V AC).</li><li>4. Plug in both power cords and make sure they are fully inserted.</li><li>5. Turn on the printer.</li></ol>
14.72:01	Zero voltage detected. <ol style="list-style-type: none"><li>1. Turn off the printer and unplug both power cords.</li><li>2. Check that the power cords are not visibly damaged.</li><li>3. Ensure that the input voltage is within specifications (180–264 V AC).</li><li>4. Plug in both power cords and make sure they are fully inserted.</li><li>5. Turn on the printer.</li></ol>

Error code	Recommendation
14.73:01	<p>Very low voltage detected.</p> <ol style="list-style-type: none"> <li>1. Turn off the printer and unplug both power cords.</li> <li>2. Check that the power cords are not visibly damaged.</li> <li>3. Ensure that the input voltage is within specifications (180–264 V AC).</li> <li>4. Plug in both power cords and make sure they are fully inserted.</li> <li>5. Turn on the printer.</li> </ol>
14.74:01	<p>Low voltage detected.</p> <ol style="list-style-type: none"> <li>1. Turn off the printer and unplug both power cords.</li> <li>2. Check that the power cords are not visibly damaged.</li> <li>3. Ensure that the input voltage is within specifications (180–264 V AC).</li> <li>4. Plug in both power cords and make sure they are fully inserted.</li> <li>5. Turn on the printer.</li> </ol>
14.75:01	<p>Excessive voltage detected.</p> <ol style="list-style-type: none"> <li>1. Turn off the printer and unplug both power cords.</li> <li>2. Check that the power cords are not visibly damaged.</li> <li>3. Ensure that the input voltage is within specifications (180–264 V AC).</li> <li>4. Plug in both power cords and make sure they are fully inserted.</li> <li>5. Turn on the printer.</li> </ol>
14.87:10	<p>Curing power regulator overtemperature detected.</p> <ol style="list-style-type: none"> <li>1. Turn off the printer.</li> <li>2. Check that the ambient temperature is within printer specifications (15–35°C).</li> <li>3. Check that the electronic enclosures at the rear of the printer are properly ventilated.</li> <li>4. Turn on the printer.</li> </ol>
16.01:00	<p>The printer is unable to warm up within a preset time limit.</p> <ol style="list-style-type: none"> <li>1. Turn off the printer and unplug both power cords.</li> <li>2. Check that the power cords are not visibly damaged.</li> <li>3. Ensure that the input voltage is within specifications (180–264 V AC).</li> <li>4. If the voltage is low, decreasing the curing temperature may help.</li> <li>5. Plug in both power cords and make sure they are fully inserted.</li> <li>6. Check that the ambient temperature is within printer specifications (15–35°C).</li> <li>7. Check that the electronic enclosures at the rear of the printer are properly ventilated.</li> <li>8. Turn on the printer.</li> </ol>

Error code	Recommendation
16.02:00	<p>The printer is unable to cool down within a preset time limit.</p> <ol style="list-style-type: none"> <li>1. Check that all fans are working and unblocked when printing.</li> <li>2. Turn off the printer.</li> <li>3. Check that the ambient temperature is within printer specifications (15–35°C).</li> <li>4. Check that the electronic enclosures at the rear of the printer are properly ventilated.</li> <li>5. Turn on the printer.</li> </ol>
16.03:00	<p>Excessive heat in the printer.</p> <ol style="list-style-type: none"> <li>1. Check that the ambient temperature is within printer specifications (15–35°C).</li> <li>2. Reduce the curing temperature and/or increase the number of passes.</li> <li>3. Check that all fans are unblocked.</li> </ol>
16.04:00	<p>Insufficient heat in the printer. Check that the ambient temperature is within printer specifications (15–35°C).</p>
16.11:10	<p>Curing temperature sensor measurement out of range (temperature sensor 1 failed or not connected).</p> <ol style="list-style-type: none"> <li>1. Turn off the printer.</li> <li>2. Check that the ambient temperature is within printer specifications (15–35°C).</li> <li>3. Check that the electronic enclosures at the rear of the printer are properly ventilated.</li> <li>4. Turn on the printer.</li> </ol>
16.12:10	<p>Curing temperature sensor measurement out of range (temperature sensor 2 failed or not connected).</p> <ol style="list-style-type: none"> <li>1. Turn off the printer.</li> <li>2. Check that the ambient temperature is within printer specifications (15–35°C).</li> <li>3. Check that the electronic enclosures at the rear of the printer are properly ventilated.</li> <li>4. Turn on the printer.</li> </ol>
16.13:10	<p>Curing temperature sensor measurement out of range (temperature sensor 3 failed or not connected).</p> <ol style="list-style-type: none"> <li>1. Turn off the printer.</li> <li>2. Check that the ambient temperature is within printer specifications (15–35°C).</li> <li>3. Check that the electronic enclosures at the rear of the printer are properly ventilated.</li> <li>4. Turn on the printer.</li> </ol>
16.14:10	<p>Curing temperature sensor measurement out of range (temperature sensor 4 failed or not connected).</p> <ol style="list-style-type: none"> <li>1. Turn off the printer.</li> <li>2. Check that the ambient temperature is within printer specifications (15–35°C).</li> <li>3. Check that the electronic enclosures at the rear of the printer are properly ventilated.</li> <li>4. Turn on the printer.</li> </ol>
16.84:03, 16.85:03	<p>Air curtain resistor out of range. Check that the air curtain fans (at the front of the curing module) are working and unblocked.</p>

Error code	Recommendation
21:13	<p>Unable to move the maintenance cartridge along its whole path.</p> <ol style="list-style-type: none"> <li>1. Turn off the printer.</li> <li>2. While the printer is off, remove the printhead maintenance cartridge manually.</li> <li>3. Make sure that the printhead maintenance cartridge path is clear. Remove any visible obstacles (paper, plastic parts, and so on) restricting the movement.</li> <li>4. Reinstall the printhead maintenance cartridge.</li> <li>5. Turn on the printer.</li> <li>6. If the error persists, replace the maintenance cartridge.</li> </ol>
21.2:10	<p>Maintenance cartridge error.</p> <ol style="list-style-type: none"> <li>1. Turn off the printer.</li> <li>2. Remove and reinsert the maintenance cartridge.</li> <li>3. Turn on the printer.</li> <li>4. If the error persists, replace the maintenance cartridge.</li> </ol>
21.5:03	<p>The part that advances the printhead maintenance cartridge web wipe is blocked.</p> <ol style="list-style-type: none"> <li>1. Turn off the printer.</li> <li>2. Remove and reinsert the maintenance cartridge.</li> <li>3. Turn on the printer.</li> <li>4. If the error persists, replace the maintenance cartridge.</li> </ol>
25.n:10 (where n = the ink cartridge number)	<p>A possible error in the ink cartridge pressure sensor has been detected. The ink level reported may not be accurate. Call your service representative if feasible.</p>
27.1:00	<p>Several blocked nozzles have been detected in the optimizer printhead. If print quality is not acceptable, clean or replace the printhead.</p>
27.n:01 (where n = the printhead slot number)	<p>A large number of blocked nozzles have been detected in one or more printheads. Calibration may have failed due to low printhead performance. Clean all the printheads and check their status.</p>
29:00	<p>The maintenance cartridge (part number CZ681A) is almost full. It will need to be replaced soon.</p>
29:01	<p>The maintenance cartridge is not inserted correctly.</p> <ol style="list-style-type: none"> <li>1. Open the maintenance cartridge door on the right of the printer.</li> <li>2. Make sure that the maintenance cartridge is correctly seated, then close the door.</li> <li>3. If the error persists, replace the maintenance cartridge.</li> </ol>
29.1:01	<p>Unable to track the maintenance cartridge status. Check, visually, that the maintenance cartridge has a correct status pattern on it.</p>
29.2:00	<p>Unable to advance the printhead cleaning roll. Replace the maintenance cartridge.</p>
32:01	<p>The take-up reel is disconnected. If you want to use the take-up reel, turn off the printer and ensure that all take-up reel cables are connected (sensor cables, printer cable). If you do not want to use it, you may need to unload the substrate manually from the take-up reel. Remember to cut the substrate first.</p>

Error code	Recommendation
32:01.1, 32:01.2	<p>This error occurs when the tension bar stays in one of its sensor trigger positions for more than 8 seconds. The most likely causes of this error are as follows:</p> <ul style="list-style-type: none"> <li>• The winding-direction switch on the take-up reel motor is activated, but substrate has not been taped to the take-up reel yet.</li> <li>• The wrong take-up reel winding direction has been selected.</li> <li>• Something is blocking the movement of the tension bar.</li> <li>• The substrate is not following the correct path between the tension bar and the diverter.</li> </ul>
32:02	<p>This error occurs during printer initialization, to warn you that the take-up reel has been disconnected while the printer was turned off. It also occurs if you try to enable the take-up reel, but it is not connected to the printer. Connect the take-up reel to the printer and press <b>OK</b> to continue.</p>
41:03	<p>Electrical current limit in paper motor.</p> <ol style="list-style-type: none"> <li>1. Turn off the printer.</li> <li>2. Open the window and check for any visible obstacles restricting the advance of the substrate. If there is a wrinkled mass of substrate inside the substrate path, lift the substrate pinch lever and clear the obstruction. Carefully remove as much as possible of the jammed substrate from the top of the printer. Cut the substrate if necessary. See also <a href="#">Substrate has jammed on page 81</a>.</li> </ol> <p><b>CAUTION:</b> Try to avoid pulling the substrate out from the input path, because this reverses the normal direction of movement, and could damage printer parts.</p> <ol style="list-style-type: none"> <li>3. Turn on the printer.</li> </ol>
42:03	<p>Scan-axis motor electrical current limit.</p> <ol style="list-style-type: none"> <li>1. Turn off the printer.</li> <li>2. Open the window and check for any visible obstacles restricting the advance of the substrate. If there is a wrinkled mass of substrate inside the substrate path, lift the substrate pinch lever and clear the obstruction. Carefully remove as much as possible of the jammed substrate from the top of the printer. Cut the substrate if necessary. See also <a href="#">Substrate has jammed on page 81</a>.</li> <li>3. Turn on the printer.</li> </ol>
63:04	<p>An input/output problem has occurred in the network card.</p> <ol style="list-style-type: none"> <li>1. Make sure that the network cable is correctly connected to the network card.</li> <li>2. Check that your printer firmware is up to date. See <a href="#">Firmware update on page 157</a>.</li> </ol>
63:05	<p>The job is reaching the printer too slowly. The printer cancels the job if there are long pauses of more than 20 s.</p> <ol style="list-style-type: none"> <li>1. Make sure that a 1 Gigabit Ethernet card is correctly installed in the computer with the RIP.</li> <li>2. Check the RIP for any error messages. Check that the computer with the RIP is working correctly and has the minimum specification required by the RIP. Check that the hard disk is neither full nor excessively fragmented.</li> <li>3. Check whether the option <b>RIP while printing</b> is enabled. This option can cause slow printing if the computer is not sufficiently powerful.</li> <li>4. Try reducing the resolution of the job or increasing the number of passes.</li> <li>5. Check that all the components of your LAN are operating at Gigabit speed.</li> </ol>
68:03	<p>There has been a loss of permanent data, such as configuration or accounting data. This can happen after a firmware update with a data structure not compatible with the older version.</p>



Error code	Recommendation
74:01	An error occurred when uploading the firmware update file. <ol style="list-style-type: none"> <li>1. Turn off the printer by using the <b>Power</b> key on the front panel and the power switch at the rear of the printer. Disconnect the power cord, then reconnect the power cord and turn on the printer.</li> <li>2. Try again to upload the firmware update file to the printer. See <a href="#">Firmware update on page 157</a>.</li> </ol>
78:08	Borderless printing is not possible. If you have a 365 or 375 printer, install the ink collector. See <a href="#">Ink collector (365 and 375 only) on page 55</a> .
78.1:04	The printer has no substrate preset for this substrate. Follow the firmware update procedure to update the printer with the latest substrate presets. See <a href="#">Firmware update on page 157</a> .
78.2:01	The back tension is lost. This could be due to a loose roll core or an imminent end of roll. If these are not the causes, try unloading and reloading the substrate.
78.3:08	Printing with the ink collector is not available in this print mode.
79:03, 79:04, 79.2:04	Generic firmware error. Update the printer's firmware. See <a href="#">Firmware update on page 157</a> .
81:01, 81.1:01, 81:03	It was impossible to stop the servo correctly before setting the encoder position. <ol style="list-style-type: none"> <li>1. Turn off the printer.</li> <li>2. Open the window, observing all safety procedures, and check for any visible obstacles restricting the movement of the drive roller. If there is a wrinkled mass of substrate inside the substrate path, lift the pinchwheels (using the substrate lever) and clear the obstruction. See also <a href="#">Substrate has jammed on page 81</a>.</li> <li>3. Turn on the printer.</li> </ol>
86:01, 86.2:01	There is a problem in the carriage assembly. <ol style="list-style-type: none"> <li>1. Turn off the printer.</li> <li>2. Open the window, observing all safety procedures, and check for any visible obstacles restricting the movement of the carriage. If there is a wrinkled mass of substrate inside the substrate path, lift the pinchwheels (using the substrate lever) and clear the obstruction. See also <a href="#">Substrate has jammed on page 81</a>.</li> <li>3. Turn on the printer.</li> </ol>
87:01	The scan-axis encoder strip is detecting errors in the carriage position. Clean the encoder strip. See <a href="#">Clean the encoder strip on page 152</a> .
89:11, 89.1:10, 89.2:10	The interior-light PCA may be failing or disconnected. The printer will continue operating normally, with only this functionality affected.
94:01	Color cannot be calibrated on this substrate. White substrate measurement is out of range.
94:02	Inconsistent colors found. <ol style="list-style-type: none"> <li>1. Check that the substrate-type selection in the front panel corresponds to an actual substrate loaded.</li> <li>2. Retry calibration.</li> </ol>
94:08	Color calibration failed. Try again. See <a href="#">Color calibration on page 99</a> .
98:03	One or more printheads are malfunctioning. Use the printhead status plot to find out which printheads are malfunctioning, and replace them. See <a href="#">1. Printhead status plot on page 109</a> .

## Printer logs

If you go to the front panel and press , then **Setup > Printer logs**, you can choose to display on the front panel a log of recent system errors, warnings, or printhead or ink cartridge events.

# 11 Printer specifications

## Functional specifications

### HP No. 831 ink supplies

Printheads	Cyan/black, yellow/magenta, light magenta/light cyan, and optimizer
Ink cartridges	Yellow, black, magenta, light magenta, cyan, light cyan, and optimizer; all cartridges contain 775 ml of ink (3 liters for the 375 printer)
Maintenance cartridge	Non-color-specific

### Substrate sizes (315 printer)

	Minimum	Maximum
Width	584 mm (23 in) Narrow substrate: 254 mm (10 in)	1372 mm (54 in)
Length	1.5 m (59 in)	Roll with maximum external diameter of 180 mm (7.1 in)
Weight		25 kg (55 lb)

### Substrate sizes (335, 365, 375 printers)

	Minimum	Maximum
Width	584 mm (23 in) Narrow substrate: 254 mm (10 in)	1626 mm (64 in)
Length	1.5 m (59 in)	Roll with maximum external diameter of 250 mm (9.8 in)
Weight		42 kg (93 lb)

The 300 series printers support substrate core diameters of 76.2 mm (3 in) and 50.8 mm (2 in).

However, the 365 and 375 printers require an accessory to support 50.8 mm (2 in) cores.

## Printing speeds

Passes	Approximate printing speed (m <sup>2</sup> /h)		
	HP Latex 365/375	HP Latex 335	HP Latex 315
2	65.5	45.1	42.4
4	31.1	24.8	24.1
6	22.8	14.8	14.2
8	17.1	12.4	12.0
10	13.9	9.9	9.7
12	11.5	8.3	8.0
16	6.4	6.2	6.0
18	5.7	5.0	4.7
20	5.0	4.5	4.2

 **NOTE:** Environmental conditions, job length, and ink density influence the maximum speed you can achieve with a particular print mode. Special-purpose options such as the use of the ink collector also have an effect on printing speed.

The maximum print resolution of the printer is 1200 × 1200 dpi. See your RIP documentation to find the resolutions supported by your RIP.

## Margins

Side margins	5 mm (0.2 in), or 10 mm (0.4 in) with edge holders
Top margin (leading edge)	5 mm (0.2 in)
Bottom margin (trailing edge)	5 mm (0.2 in) (none) 100 mm (3.9 in) (small) 150 mm (5.9 in) (normal) 200 mm (7.9 in) (extra) 300 mm (11.8 in) (extra) 400 mm (15.7 in) (extra) 500 mm (19.7 in) (extra)

 **NOTE:** When the ink collector is in use with the 365 or 375 printer, and you are using a print mode with more than 10 passes, full bleed is available (no side margins).

## Physical specifications

### Printer physical specifications

	HP Latex 315	HP Latex 335	HP Latex 365/375
Weight (including stand)	174 kg (384 lb)	188 kg (414 lb)	207 kg (456 lb)
Width	2307 mm (90.8 in)	2561 mm (101 in)	2561 mm (101 in)
Depth	840 mm (33.1 in)	840 mm (33.1 in)	840 mm (33.1 in)
Height	1380 mm (54.3 in)	1380 mm (54.3 in)	1380 mm (54.3 in)
Weight with packaging	290 kg (639 lb)	304 kg (670 lb)	323 kg (712 lb)
Width with packaging	2541 mm (100 in)	2795 mm (110 in)	2795 mm (110 in)
Depth with packaging	765 mm (30.1 in)	765 mm (30.1 in)	765 mm (30.1 in)
Height with packaging	1239 mm (48.8 in)	1239 mm (48.8 in)	1239 mm (48.8 in)

## Memory specifications

### Memory specifications

Physical memory (DRAM)	1 GB
Hard disk	16 GB

## Power specifications

### Single phase line specifications

	HP Latex 365/375		HP Latex 335		HP Latex 315	
	Printer	Curing	Printer	Curing	Printer	Curing
Number of power cords	2		2		2	
Input voltage	200–240 V ±10% (two wires and protective earth)					
Input frequency	50 / 60 Hz					
Maximum load current (per power cord)	16 A	16 A	3 A	16 A	3 A	13 A
Power consumption per power cord in printing mode	2.5 kW	2.1 kW	200 W	2.4 kW	200 W	2.0 kW
Power consumption in ready mode	85 W		72 W		70 W	

## Ecological specifications

For the up-to-date ecological specifications of your printer, please go to <http://www.hp.com/> and search for "ecological specifications".

# Environmental specifications

## Printer environmental specifications

Relative humidity range for best print quality	40–60%, depending on substrate type
Relative humidity range for printing	20–80%, depending on substrate type
Temperature range for best print quality	20 to 25°C (68 to 77°F), depending on substrate type
Temperature range for printing	15 to 30°C (59 to 86°F), depending on substrate type
Temperature range when not in operation	-25 to +55°C (-13 to +131°F)
Temperature gradient	no more than 10°C/h (18°F/h)
Maximum altitude when printing	3000 m (10000 ft)

 **NOTE:** The printer must be kept indoors.

 **NOTE:** If the printer or ink cartridges are moved from a cold location to a warm and humid location, water from the atmosphere can condensate on the printer parts and cartridges and can result in ink leaks and printer errors. In this case, HP recommends that you wait at least 3 hours before turning on the printer or installing the ink cartridges, to allow the condensate to evaporate.

# Acoustic specifications

## Printer acoustic specifications

		HP Latex 315	HP Latex 335	HP Latex 365/375
Sound pressure	Printing	54 dB (A)	55 dB (A)	55 dB (A)
	Ready (standby)	38 dB(A)	39 dB (A)	39 dB (A)
	Asleep	< 15 dB(A)	< 15 dB (A)	< 15 dB (A)
Sound power	Printing	7.2 B (A)	7.4 B (A)	7.4 B (A)
	Ready (standby)	5.5 B (A)	5.7 B (A)	5.7 B (A)
	Asleep	< 3.5 B (A)	< 3.5 B (A)	< 3.5 B (A)

# A Summary of common printing problems

This is a table of common problems and the parameters that can be changed in order to solve the problem. Some possible side-effects are also shown. For a more detailed treatment of any particular problem, please see the relevant chapter in this guide.

Problem	Parameter	Change	Possible side-effects
Durability problems, ink smudges, or oily finish	Curing temperature	Increase	Substrate jam, substrate damage, ink smears
	Number of passes	Increase	Slower printing
	Inter-path delay offset	Increase	Slower printing
Substrate jam, substrate damage, ink smears	Curing temperature	Decrease	Less durability (smudges), oily finish
	Vacuum	Increase	Substrate skew, vertical banding if increased too much
	Top and/or bottom margins	Increase	Waste of substrate
	Edge holders	Use	The minimum side margins increase slightly, reducing the maximum width of the printed image
Vertical banding in saturated area fills	Ink limits	Decrease	Reduced color gamut
	Inter-path delay offset	Increase	Slower printing
	Number of passes	Increase	Slower printing
	Cutter	Disable	Manual substrate advance may be needed to avoid crashes with some substrates
	Group jobs together	Yes	Avoids white space between prints
	Modify the print queue	Avoid printing difficult jobs (using a lot of ink) at the beginning of the queue	
Horizontal banding in saturated area fills	Ink limits	Decrease	Reduced color gamut
	Inter-path delay offset	Increase	Slower printing
	Number of passes	Increase	Slower printing
	Modify color separations and dark color generation		
	Align printheads		
	Clean substrate-advance sensor		
	Clean printheads		
Vertical banding in low-to-medium area fills	Align printheads		
	Ink limits	Increase	

Problem	Parameter	Change	Possible side-effects
	Inter-path delay offset	Increase	Slower printing
	Vertical correction	Activate	Grainy aspect
	Take-up reel (335, 365, and 375)	Use	
	Number of passes	Increase	Slower printing
	Modify the print queue	Avoid printing difficult jobs (using a lot of ink) at the beginning of the queue	
	Roll-back tension	Increase	Grain and/or horizontal banding may appear if too high
	Warm up printer	Activate in RIP	Delays the start of printing, without reducing printing speed
Coalescence graininess in low-to-medium area fills	Align printheads		
	Ink limits	Increase	
	Inter-path delay offset	Increase	Slower printing
	Modify the print queue	Avoid printing difficult jobs (using a lot of ink) at the beginning of the queue	
	Warm up printer	Activate in RIP	Delays the start of printing, without reducing printing speed
	Efficiency mode	Activate	Reduced color gamut, graininess
	Number of passes	Increase	Slower printing
	Optimizer level	Increase	Reduced gloss in dark area fills. With some substrates, may have no effect on coalescence.
	Dirty roll or defective coating	Consider trying a new roll. Some substrates deteriorate during long periods of storage.	
Graininess, color misregistration or lack of sharpness	Align printheads		
	Vertical correction	Remove	
	Clean substrate-advance sensor		
	Calibrate substrate advance		
Black areas look hazy or image gloss is not uniform	Modify color separations and dark color generation		
	Number of passes	Increase	Slower printing
	Curing temperature	Decrease	Less durability (smudges), oily finish
Bleeding between inks or wicking into white areas	Align printheads		
	Align optimizer manually	If necessary, load a self-adhesive vinyl to achieve good alignment	
	Ink limits	Decrease	Reduced color gamut
	Optimizer level	Increase	Reduced gloss in dark area fills. With some substrates, may have no effect on bleeding or wicking.
	Clean optimizer printhead		
Lack of sharpness in text or solid areas	Align printheads		
	Align optimizer manually	If necessary, load a self-adhesive vinyl to achieve good alignment.	

Problem	Parameter	Change	Possible side-effects
	Color bars	Add, manually or in RIP	Some waste of substrate and ink
	Color-variation and text-line correction	Apply	White areas may appear slightly different.
Subtle color variations in solid areas	Color bars	Add, manually or in RIP	Some waste of substrate and ink
	Color-variation and text-line correction	Apply	White areas may appear slightly different.



---

# Glossary

**Airflow**

Air is blown through the printing zone to speed up the drying process.

**Back tension**

The backwards tension applied to the substrate by the input spindle, which must be constant across the width of the substrate. Too much or too little tension may cause substrate deformation and print quality defects.

**Bidirectional**

Bidirectional printing means that the printheads print while moving in both directions. This increases the speed of printing.

**Bleeding**

A print-quality defect that occurs when the ink spreads on the substrate across areas of different colors.

**Coalescence**

A print-quality defect that occurs when the ink coalesces on the substrate within an area of the same color.

**Cockle**

A substrate condition in which it is not lying perfectly flat, but rises and falls slightly in shallow waves.

**Color accuracy**

The ability to print colors that match the original image as closely as possible, given the fact that all devices have a limited color gamut and might not be able to match certain colors precisely.

**Color consistency**

The ability to print the same colors in a particular print job, from print to print and from printer to printer.

**Curing**

The substrate is heated in the curing zone to coalesce the latex, creating a polymeric film which acts as a protective layer, while at the same time removing the remaining co-solvents from the print. Curing is vital to ensure the durability of the printed images. Too high or too low a curing temperature may cause print quality defects.

**Cutter**

A printer component that slides from left to right across the platen to cut the substrate.

**Edge holder**

A metal piece designed to prevent the edge of the substrate from rising while printing is in progress.

**ESD**

ElectroStatic Discharge. Static electricity is common in daily life. It is the spark when touching the car door, or the cling of clothing. Although controlled static electricity has some useful applications, uncontrolled electrostatic discharges are one of the main hazards to electronic products. Therefore, to prevent damage some precautions are needed when setting up the product, or handling ESD-sensitive devices. This type of damage may reduce the life expectancy of the device. One way to minimize uncontrolled ESDs, and therefore to reduce this type of damage, is by touching any exposed grounded part of the product (mainly metal parts) before handling ESD-sensitive devices, such as the printheads or ink cartridges. To reduce the generation of electrostatic charge in your body, try to avoid working in a carpeted area, keep your body movements to a minimum when handling ESD-sensitive devices, and avoid working in low-humidity environments.

**Firmware**

Software that controls your printer's functionality and is stored semi-permanently in the printer (it can be updated).

**Gamut**

The range of colors and density values reproducible on an output device, such as a printer or monitor.

**HDPE**

High Density Polyethylene.

**I/O**

Input/Output: this term describes the passing of data between one device and another.

**ICC**

The International Color Consortium, a group of companies that have agreed on a common standard for color profiles.

**Ink density**

The relative amount of ink that is deposited on the substrate per unit of area.

**IP address**

A unique identifier that identifies a particular node on a TCP/IP network. It consists of four integers separated by dots.

**LED**

Light-Emitting Diode: a semiconductor device that emits light when electrically stimulated.

**Loading accessory**

A flexible plastic accessory that fits over the leading edge of the substrate while it is being loaded into the printer. Some substrates are difficult to load without this accessory.

**Nozzle**

One of many tiny holes in a printhead through which ink is deposited onto the substrate.

**OMAS**

The Optical Media Advance Sensor, otherwise known as the substrate-advance sensor. The sensor located in the print platen that tracks the substrate movement and increases its accuracy.

**Passes**

The number of print passes specifies how many times the printheads will print on the same area of substrate. A higher number of passes tends to improve print quality and printhead health, but reduces the speed of printing.

**PC**

Polycarbonate.

**PE**

Polyethylene.

**PET**

Polyethylene Terephthalate (polyester).

**PLA**

Polylactic Acid.

**Platen**

The flat surface within the printer over which the substrate passes while it is being printed on.

**PP**

Polypropylene.

**Printhead**

A removable printer component that takes ink of one or more colors from the corresponding ink cartridge(s) and deposits it on the substrate, through a cluster of nozzles.

**PVC**

Polyvinyl Chloride.

**Spindle**

A rod that supports a roll of substrate while it is being used for printing.

**Substrate**

A thin, flat material designed to be printed on, made of paper or other materials.

**Substrate preset**

The substrate preset contains the ICC color profile, which describes the color characteristics of the substrate. It also contains information about other characteristics (RIP and printer settings, such as drying and curing temperatures, vacuum pressure, and substrate-advance compensation) and requirements of the substrate that are not directly related to color.

**Substrate-advance compensation**

A slight adjustment to the amount of substrate advance between print passes, to compensate for the characteristics of different substrate types. The printer normally performs this adjustment automatically, but may need to be recalibrated for substrates not supported by HP, or for an unusual ambient temperature or humidity. Incorrect substrate-advance compensation may cause banding with fewer than 8 passes, or graininess with 8 passes or more.

**Substrate-advance sensor**

The sensor located in the print platen that tracks the substrate movement and increases its accuracy. Also known as OMAS (Optical Media Advance Sensor).

**Tension bar**

A cylindrical weight inserted into the loop of substrate required by the take-up reel.

**Vacuum pressure**

The substrate is held flat against the platen by vacuum suction. Too much or too little suction may cause print quality defects. Too little suction may also cause a substrate jam or damage the printheads.

---

# Index

- A**
  - access control 24
  - accessories
    - order 161
  - accounting 27
  - acoustic specifications 175
  - alerts
    - by email 26
  - altitude 14
  - application hangs up 164
  - audio alerts on/off 14
- B**
  - bow deformation 85
  - brightness of front panel 14
  - bypass job start safety 80
- C**
  - calibration
    - color 99
  - cannot load substrate 80
  - carriage rod
    - clean and lubricate 150
  - caution 6
  - color calibration 99
  - color consistency 104
  - color consistency between printers 103
  - color profiles 103
  - communication problems 165
  - components of printer 8
  - connect the printer
    - connection method 28
    - general 28
  - connect to the Internet 30
  - curve deformation 85
  - Customer Care 38
  - Customer Self Repair 39
  - cutter
    - disable 98
  - cutter does not work 86
- D**
  - date and time 13
  - DHCP not available 163
  - DHCP settings 33
  - DNS settings 33
  - documentation 3
  - double-sided printing 77
- E**
  - ecological specifications 174
  - edge holders 65
  - edge position, change 79
  - email alerts 26
  - Embedded Web Server 22
    - access 23
    - cannot access 163
    - ink system status 26
    - language 24
  - encoder strip
    - clean 152
  - environmental specifications 175
- F**
  - faster printing 98
  - file system check 17
  - firmware update 157
  - front panel 11
    - language 13
  - front view 9
  - front-panel error codes 166
  - front-panel options
    - adjust substrate advance 96, 114
    - adjustments 96
    - allow EWS 163
    - audio alert 14
    - auto printhead alignment 134
    - change loaded substrate 62
    - clean printheads 134
    - connectivity wizard 30, 165
    - curing standby duration 14
    - cutter 86, 98
    - date and time options 13
    - enable narrow substrate 52, 63
    - enable take-up reel 86
    - extra bottom margin 19, 83, 84
    - extra top margin 19, 83, 84
    - feed and cut 79
    - file system check 17
    - form feed and cut 78
    - internal prints 19
    - language 13
    - load 52
    - load roll 52
    - manual printhead alignment 135
    - max skew setting 62
    - modify configuration 163
    - move substrate 77
    - network information 163
    - print connectivity config. 165
    - print usage report 19
    - printer logs 171
    - replace ink cartridges 130
    - replace PH cleaning kit 147
    - replace printheads 136
    - reset EWS password 24
    - restore factory settings 14
    - select altitude 14
    - select display contrast 14
    - sleep mode wait time 13, 14
    - speaker volume 14
    - substrate advance calib 114
    - substrate unload 78
    - take-up reel 69, 76
    - unit selection 14
    - unload 68
    - unload substrate 68
    - use loading accessory 59
    - view printer information 38
- G**
  - functional specifications 172
  - graininess 115
- H**
  - hard disk specification 174
  - HP Customer Care 38

HP Latex Mobile 20

## I

ICC profiles 103  
ink cartridge  
  about 125  
  cannot insert 133  
  maintenance 129  
  non-HP 132  
  ordering 159  
  refill 132  
  replace 129  
  specification 172  
  status 15  
ink collector 55  
ink system status 26  
ink system tips 129  
internal prints 19  
Internet connection 30  
  troubleshooting 165  
IP address 33  
IP address, set manually 163  
IPv6 29  
IPV6 settings 33

## J

job accounting 27  
job start safety, bypass 80

## L

labels, warning 6  
language 13  
link speed 35  
loading accessory 59  
loading substrate problems 80  
loading thick substrates 62  
loading thin substrates 62  
loudspeaker volume 14

## M

maintenance cartridge  
  about 126  
  cannot insert 150  
  replace 147  
  specification 172  
maintenance, service 156  
manuals 3  
margins  
  changing 19  
  specification 173  
memory specifications 174  
mobile app 20

## N

network configuration  
  advanced 30  
network troubleshooting 31  
networks  
  link speed 35  
  protocols 32  
  security settings 35  
non-HP ink cartridges 132

## O

optimizer  
  about 125  
order  
  accessories 161  
  ink cartridges 159  
  printhead cleaning kit 161  
  printheads 160

## P

physical specifications 174  
platen  
  clean 153  
porous substrates 46  
power specifications 174  
print quality, improve 109  
print-quality problems  
  black areas look hazy 119  
  color variation 118  
  general 108  
  graininess 115  
  horizontal banding 115  
  ink smears 119  
  ink smudges 120  
  misaligned colors 117  
  oily ink 120  
  text-line correction 118  
  tiling 121  
  uneven area fill 120  
  vertical banding 116  
  wrong size 120

## printer

  clean 155  
  move 155  
  store 155  
Printer Data Sharing Agreement 24  
printer does not print 163  
printer logs 171  
printer models 2  
printer states 18  
printer status 26  
printer usage statistics 27  
printer's main components 8  
printer's main features 2

## printhead

  about 125  
  align 134  
  alignment status plot 112  
  cannot insert 142  
  clean 133  
  cleaning connections 143  
  optimizer check plot 110  
  ordering 160  
  recover 133  
  replace 136  
  reset 136  
  specification 172  
  status 16  
  status plot 109  
printing delays 18  
printing faster 98  
printing speeds 173  
protocols, network 32  
Proxy Server settings 34

## Q

QR code 3  
Quick Solutions 108

## R

rear view 10  
refilled ink cartridges 132  
restart the printer 37  
restore factory settings 14  
right edge position, change 79  
RIP software installation 30

## S

safe mode 127  
safety labels 6  
safety precautions 3  
security 24  
  network settings 35  
service information print 39  
service maintenance 156  
sleep mode wait time 14  
slow printing 164  
specifications  
  acoustic 175  
  ecological 174  
  environmental 175  
  functional 172  
  hard disk 174  
  ink supplies 172  
  margins 173  
  memory 174  
  physical 174  
  power 174

- printing speeds 173
- substrate size 172
- straightness optimization 85
- substrate
  - advance 113
  - assisted manual load 63
  - bow deformation 85
  - cannot load 80
  - categories 43
  - change settings while printing 96
  - check path 82
  - displaying information 78
  - edge holders 65
  - edge position, change 79
  - expansion 84
  - feed and cut 79
  - ink collector 55
  - jam 81
  - jam, take-up reel 86
  - length tracking 79
  - load 52
  - load cut sheet 67
  - load onto spindle 47
  - loading accessory 59
  - manual load 63
  - mispositioned 81
  - overview 42
  - porous 46
  - print on both sides 77
  - shrinkage 84
  - sizes (max & min) 172
  - sticky 86
  - storage 80
  - take-up reel 69
  - tips 42
  - unload 68
  - width, change 79
  - wrinkled 84
- substrate presets 89
  - clone 92
  - create 94
  - delete 98
  - generic 92
  - HP Media Locator 91
  - modify 93
  - online search 89
- substrate-advance adjustment 113
- substrate-advance check plot 113
- substrate-advance sensor window
  - clean 154
- support services
  - HP Customer Care 38

## T

- take-up reel
  - doesn't rewind 86
  - jam 86
  - motor 10
  - using 69
- TCP/IP settings 32
- telephone number 39
- telephone support 38
- tension bar 69
- tiling 104
- time before standby 14
- turn the printer on/off 36

## U

- units of measurement 14

## W

- warning 6
- warning labels 6
- welcome to your printer 2